

PROJECT PRICE LIST

— EFFECTIVE APRIL 2022 —

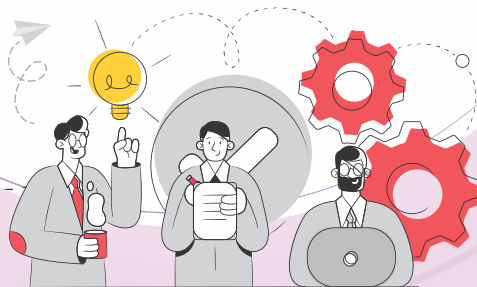
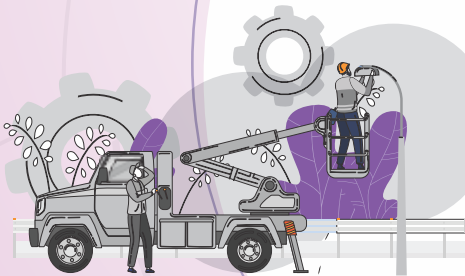

**MINIATURE
CIRCUIT BREAKER**

**MOULDED CASE
CIRCUIT BREAKER**

**DISTRIBUTION
BOARD**

**ONLOAD
CHANGEOVER**

**FEEDER
PILLAR**

**WIRING
DEVICES**

Contents

—optipro—	MINIATURE CIRCUIT BREAKER (MCBs)	01 - 04
—optipro—	AC CIRCUIT BREAKER	05
—optipro—	DC CIRCUIT BREAKER	05 - 06
—optipro—	DC MCB WITH EXTENDED LINK AS PER RDSO	06
—optipro—	ISOLATOR	07
—optipro—	RESIDUAL CURRENT CIRCUIT BREAKER (RCCBs)	07
—optipro—	RCD ADD ON BLOCK	08
—optipro—	ACCESSORIES	08
—optipro—	DISTRIBUTION BOARDS (DBs)	10 - 16
	BUSBAR CHAMBER	17
	TIME SWITCHES	18
	TIMELITE DISTRIBUTION BOARDS	19
—optium—	1.0 (FIXED TM RANGE)	20 - 22
—optium—	2.0 (ADJUSTABLE TM RANGE)	22 - 24
—optium—	2.1 (ELECTRONIC / MICRO -PROCESSOR RANGE)	24
—optium—	OPTIUM 2.2 (WITH ELECTRONIC / MICRO PROCESSOR RELEASE)	24
—optium—	2.2 (ELECTRONIC / MICRO -PROCESSOR RANGE)	25
—optium—	ACCESSORIES	25 - 27
—optipro—	SMDB	29 - 31
	HRC FUSE LINKS & BASES	33
	SWITCH DISCONNECTOR FUSES	34
	Ambidex CHANGEOVER SWITCHES	36
	REWIRABLE SWITCH FUSE UNITS	37
	Glint [™] WIRING ACCESSORIES	39 - 41
	ELVIRA WIRING ACCESSORIES	44 - 48
	INDOASIAN PLUGS	48
	EXHAUST FAN	48

—optipro— **MINIATURE CIRCUIT BREAKER - MCB**

- ISI / CE Marked as per IS/IEC 60898 - 1 • Rated Short-Circuit Breaking Capacity, Icn 10kA • Degree of Protection IP 20
- Energy Limitation Class 3 • Line Load Reversibility • 35 sq. mm Terminals • Biconnect Terminals • Frequency: 50 Hz
- Operating Voltage : 240V/415V AC , 60V DC per pole

B CURVE SINGLE POLE

HSN Code: 8536

	Rating (A)	Pack	Cat. Nos.	Unit Price (₹)
	6	1/12/180	811008	250
10	1/12/180	811010	250	
16	1/12/180	811012	250	
20	1/12/180	811013	250	
25	1/12/180	811014	250	
32	1/12/180	811015	250	
40	1/12/180	811016	566	
50	1/12/180	811017	660	
63	1/12/180	811018	660	

B CURVE SINGLE POLE NEUTRAL

HSN Code: 8536

	Rating (A)	Pack	Cat. Nos.	Unit Price (₹)
	6	1/6/90	811027	844
10	1/6/90	811029	844	
16	1/6/90	811031	844	
20	1/6/90	811032	844	
25	1/6/90	811033	844	
32	1/6/90	811034	844	
40	1/6/90	811035	1184	
50	1/6/90	811036	1340	
63	1/6/90	811037	1340	

B CURVE DOUBLE POLE

HSN Code: 8536

	Rating (A)	Pack	Cat. Nos.	Unit Price (₹)
	6	1/6/90	811046	878
10	1/6/90	811048	878	
16	1/6/90	811050	878	
20	1/6/90	811051	878	
25	1/6/90	811052	878	
32	1/6/90	811053	878	
40	1/6/90	811054	1264	
50	1/6/90	811055	1408	
63	1/6/90	811056	1408	

C CURVE SINGLE POLE

HSN Code: 8536

	Rating (A)	Pack	Cat. Nos.	Unit Price (₹)
	0.5	1/12/180	811114	442
1	1/12/180	811115	442	
2	1/12/180	811117	442	
3	1/12/180	811119	442	
4	1/12/180	811120	442	
5	1/12/180	811121	442	
6	1/12/180	811122	264	
10	1/12/180	811124	264	
16	1/12/180	811126	264	
20	1/12/180	811127	264	
25	1/12/180	811128	264	
32	1/12/180	811129	264	
40	1/12/180	811130	532	
50	1/12/180	811131	634	
63	1/12/180	811132	634	

—optipro— **MINIATURE CIRCUIT BREAKER - MCB**

C CURVE SINGLE POLE NEUTRAL

HSN Code: 8536

	Rating (A)	Pack	Cat. Nos.	Unit Price (₹)
	0.5	1/6/90	811136	926
	1	1/6/90	811137	926
	2	1/6/90	811139	926
	3	1/6/90	811141	926
	4	1/6/90	811142	926
	5	1/6/90	811143	926
	6	1/6/90	811144	870
	10	1/6/90	811146	870
	16	1/6/90	811148	870
	20	1/6/90	811149	870
	25	1/6/90	811150	870
	32	1/6/90	811151	870
	40	1/6/90	811152	1230
	50	1/6/90	811153	1386
	63	1/6/90	811154	1386

C CURVE DOUBLE POLE

HSN Code: 8536

	Rating (A)	Pack	Cat. Nos.	Unit Price (₹)
	0.5	1/6/90	811158	1062
	1	1/6/90	811159	1062
	2	1/6/90	811161	1062
	3	1/6/90	811163	1062
	4	1/6/90	811164	1062
	5	1/6/90	811165	1062
	6	1/6/90	811166	894
	10	1/6/90	811168	894
	16	1/6/90	811170	894
	20	1/6/90	811171	894
	25	1/6/90	811172	894
	32	1/6/90	811173	894
	40	1/6/90	811174	1298
	50	1/6/90	811175	1456
	63	1/6/90	811176	1456

6

C CURVE THREE POLE

HSN Code: 8536

	Rating (A)	Pack	Cat. Nos.	Unit Price (₹)
	0.5	1/4/60	811180	1630
	1	1/4/60	811181	1630
	2	1/4/60	811183	1630
	3	1/4/60	811185	1630
	4	1/4/60	811186	1630
	5	1/4/60	811187	1630
	6	1/4/60	811188	1398
	10	1/4/60	811190	1398
	16	1/4/60	811192	1398
	20	1/4/60	811193	1398
	25	1/4/60	811194	1398
	32	1/4/60	811195	1398
	40	1/4/60	811196	2026
	50	1/4/60	811197	2140
	63	1/4/60	811198	2140

—optipro— **MINIATURE CIRCUIT BREAKER - MCB**

C CURVE THREE POLE NEUTRAL

HSN Code: 8536

	Rating (A)	Pack	Cat. Nos.	Unit Price (₹)
	0.5	1/3/45	811202	2092
1	1/3/45	811203	2092	
2	1/3/45	811205	2092	
3	1/3/45	811207	2092	
4	1/3/45	811208	2092	
5	1/3/45	811209	2092	
6	1/3/45	811210	1800	
10	1/3/45	811212	1800	
16	1/3/45	811214	1800	
20	1/3/45	811215	1800	
25	1/3/45	811216	1800	
32	1/3/45	811217	1800	
40	1/3/45	811218	2396	
50	1/3/45	811219	2536	
63	1/3/45	811220	2536	

C CURVE FOUR POLE

HSN Code: 8536

	Rating (A)	Pack	Cat. Nos.	Unit Price (₹)
	0.5	1/3/45	811224	2122
1	1/3/45	811225	2122	
2	1/3/45	811227	2122	
3	1/3/45	811229	2122	
4	1/3/45	811230	2122	
5	1/3/45	811231	2122	
6	1/3/45	811232	1992	
10	1/3/45	811234	1992	
16	1/3/45	811236	1992	
20	1/3/45	811237	1992	
25	1/3/45	811238	1992	
32	1/3/45	811239	1992	
40	1/3/45	811240	2704	
50	1/3/45	811241	2764	
63	1/3/45	811242	2764	

D CURVE SINGLE POLE

HSN Code: 8536

	Rating (A)	Pack	Cat. Nos.	Unit Price (₹)
	0.5	1/12/180	811246	452
1	1/12/180	811247	452	
2	1/12/180	811249	452	
3	1/12/180	811251	452	
4	1/12/180	811252	452	
5	1/12/180	811253	452	
6	1/12/180	811254	386	
10	1/12/180	811256	386	
16	1/12/180	811258	386	
20	1/12/180	811259	386	
25	1/12/180	811260	386	
32	1/12/180	811261	386	
40	1/12/180	811262	638	
50	1/12/180	811263	728	
63	1/12/180	811264	728	

—optipro— **MINIATURE CIRCUIT BREAKER - MCB**

D CURVE DOUBLE POLE

HSN Code: 8536

	Rating (A)	Pack	Cat. Nos.	Unit Price (₹)
	0.5	1/6/90	811284	1198
	1	1/6/90	811285	1198
	2	1/6/90	811287	1198
	3	1/6/90	811289	1198
	4	1/6/90	811290	1198
	5	1/6/90	811291	1198
	6	1/6/90	811292	932
	10	1/6/90	811294	932
	16	1/6/90	811296	932
	20	1/6/90	811297	932
	25	1/6/90	811298	932
	32	1/6/90	811299	932
	40	1/6/90	811300	1336
	50	1/6/90	811301	1422
	63	1/6/90	811302	1422

D CURVE THREE POLE

HSN Code: 8536

	Rating (A)	Pack	Cat. Nos.	Unit Price (₹)
	0.5	1/4/60	811303	1774
	1	1/4/60	811304	1774
	2	1/4/60	811306	1774
	3	1/4/60	811308	1774
	4	1/4/60	811309	1774
	5	1/4/60	811310	1774
	6	1/4/60	811311	1418
	10	1/4/60	811313	1418
	16	1/4/60	811315	1418
	20	1/4/60	811316	1418
	25	1/4/60	811317	1418
	32	1/4/60	811318	1418
	40	1/4/60	811319	2140
	50	1/4/60	811320	2168
	63	1/4/60	811321	2168

D CURVE FOUR POLE

HSN Code: 8536

	Rating (A)	Pack	Cat. Nos.	Unit Price (₹)
	0.5	1/3/45	811341	2150
	1	1/3/45	811342	2150
	2	1/3/45	811344	2150
	3	1/3/45	811346	2150
	4	1/3/45	811347	2150
	5	1/3/45	811348	2150
	6	1/3/45	811349	1854
	10	1/3/45	811351	1854
	16	1/3/45	811353	1854
	20	1/3/45	811354	1854
	25	1/3/45	811355	1854
	32	1/3/45	811356	1854
	40	1/3/45	811357	2648
	50	1/3/45	811358	2744
	63	1/3/45	811359	2744

—optipro— **AC CIRCUIT BREAKER**

- Conforms to IEC 60947-2 • CE Marked • Rated Short-Circuit Capacity, Icu 10kA • Degree of Protection IP 20
- 1.5 Module per pole • 50 sq. mm Terminals • Frequency: 50 Hz • Operating Voltage: 240V/415V AC, 60V DC per Pole

SINGLE POLE

HSN Code: 8536

	Rating (A)	Pack	Cat. Nos.	Unit Price (₹)
	80	1	811133	2294
	100	1	811134	2542
	125	1	811135	2834

DOUBLE POLE

HSN Code: 8536

	Rating (A)	Pack	Cat. Nos.	Unit Price (₹)
	80	1	811177	5280
	100	1	811178	5680
	125	1	811179	6224

THREE POLE

HSN Code: 8536

	Rating (A)	Pack	Cat. Nos.	Unit Price (₹)
	80	1	811199	7772
	100	1	811200	8376
	125	1	811201	9100

FOUR POLE

HSN Code: 8536

	Rating (A)	Pack	Cat. Nos.	Unit Price (₹)
	80	1	811243	10158
	100	1	811244	10490
	125	1	811245	11926

—optipro— **DC CIRCUIT BREAKER**

- Conforms to IEC 60947-2 • CE Marked • Breaking Capacity 6kA • Degree of Protection IP 20 • 35 sq. mm Terminals
- Biconnect Terminals • Upto 250V Supply

SINGLE POLE

HSN Code: 8536

	Rating (A)	Pack	Cat. Nos.	Unit Price (₹)
	0.5	1/12/180	811400	594
	1	1/12/180	811401	594
	2	1/12/180	811403	594
	3	1/12/180	811405	594
	4	1/12/180	811406	594
	5	1/12/180	811407	594
	6	1/12/180	811408	532
	10	1/12/180	811410	532
	16	1/12/180	811412	532
	20	1/12/180	811413	532
	25	1/12/180	811414	532
	32	1/12/180	811415	532
	40	1/12/180	811416	706
	50	1/12/180	811417	730
	63	1/12/180	811418	730

—optipro— DC CIRCUIT BREAKER

DOUBLE POLE

HSN Code: 8536

	Rating (A)	Pack	Cat. Nos.	Unit Price (₹)
	0.5	1/6/90	811419	1338
	1	1/6/90	811420	1338
	2	1/6/90	811422	1338
	3	1/6/90	811424	1338
	4	1/6/90	811425	1338
	5	1/6/90	811426	1338
	6	1/6/90	811427	1098
	10	1/6/90	811429	1098
	16	1/6/90	811431	1098
	20	1/6/90	811432	1098
	25	1/6/90	811433	1098
	32	1/6/90	811434	1098
	40	1/6/90	811435	1500
	50	1/6/90	811436	1612
	63	1/6/90	811437	1612

OPTIPRO DC MCB WITH EXTENDED LINK AS PER RDSO

HSN Code: 8536

Rating (A)	Pack	Cat. Nos.	Unit Price (₹)
0.5	1/-/48	811451	636
1	1/-/48	811452	636
1.5	1/-/48	811453	636
1.6	1/-/48	811454	636
2	1/-/48	811455	636
2.5	1/-/48	811456	636
3	1/-/48	811457	636
4	1/-/48	811458	636
5	1/-/48	811459	636
6	1/-/48	811460	596
7.5	1/-/48	811461	596
10	1/-/48	811462	596
15	1/-/48	811463	596
16	1/-/48	811464	596
20	1/-/48	811465	596
25	1/-/48	811466	596
30	1/-/48	811467	596
35	1/-/48	811468	788
40	1/-/48	811469	788
50	1/-/48	811470	788
60	1/-/48	811471	788

—optipro— **ISOLATOR**

- Conforms to IEC 60947-3 • CE Marked • Degree of Protection IP 20 • 35 sq. mm Terminals • Biconnect Terminals
- Frequency: 50 Hz • Operating Voltage: 240V/415V AC, 60V DC per Pole

DOUBLE POLE

HSN Code: 8536

	Rating (A)	Pack	Cat. Nos.	Unit Price (₹)
	40	1/6/90	811550	554
	63	1/6/90	811551	684
	80	1/6/90	811552	884
	100	1/6/90	811553	884
	125	1/6/90	811554	952

THREE POLE

HSN Code: 8536

	Rating (A)	Pack	Cat. Nos.	Unit Price (₹)
	40	1/4/60	811555	1038
	63	1/4/60	811556	1186
	80	1/4/60	811557	1338
	100	1/4/60	811558	1338
	125	1/4/60	811559	1466

FOUR POLE

HSN Code: 8536

	Rating (A)	Pack	Cat. Nos.	Unit Price (₹)
	40	1/3/45	811560	1240
	63	1/3/45	811561	1338
	80	1/3/45	811562	1660
	100	1/3/45	811563	1660
	125	1/3/45	811564	1796

—optipro— **RESIDUAL CURRENT CIRCUIT BREAKER - RCCB**

- ISI/CE marked as per IS/IEC 12640-1 • Degree of Protection IP 20 • Rated Conditional Short-Circuit Current, Icc10kA
- 35 sq. mm Terminals • Biconnect Terminals • Frequency: 50 Hz • Operating Voltage: 240V/415V AC

DOUBLE POLE

HSN Code: 8536

	Rating (A)	Sensitivity (mA)	Pack	Cat. Nos.	Unit Price (₹)
	25	30	1/6/90	811700	3336
		100	1/6/90	811706	3336
		300	1/6/90	811712	3474
	40	30	1/6/90	811701	3428
		100	1/6/90	811707	3428
		300	1/6/90	811713	3736
	63	30	1/6/90	811702	4584
		100	1/6/90	811708	4584
		300	1/6/90	811714	4682

FOUR POLE

HSN Code: 8536

	Rating (A)	Sensitivity (mA)	Pack	Cat. Nos.	Unit Price (₹)
	25	30	1/3/45	811718	4280
		100	1/3/45	811724	4280
		300	1/3/45	811730	4444
	40	30	1/3/45	811719	4390
		100	1/3/45	811725	4390
		300	1/3/45	811731	4634
	63	30	1/3/45	811720	4750
		100	1/3/45	811726	4750
		300	1/3/45	811732	4834

—optipro— **RCD ADD ON BLOCK**

- Conforms to IEC 60947-2 • Degree of Protection IP 20
- Rated Conditional Short-Circuit Current, I_{cc} 10kA • 35 sq. mm Terminals • Dual Position DIN Clip

DOUBLE POLE

HSN Code: 8536

	Rating (A)	Sensitivity (mA)	Pack	Cat. Nos.	Unit Price (₹)
	6A - 32A	30	30	1/ - /32	811666
100		100	1/ - /32	811668	3488
300		300	1/ - /32	811670	3754
40A & 63A	30	30	1/ - /32	811667	3754
	100	100	1/ - /32	811669	4124
	300	300	1/ - /32	811671	4500

FOUR POLE

HSN Code: 8536

	Rating (A)	Sensitivity (mA)	Pack	Cat. Nos.	Unit Price (₹)
	6A - 32A	30	30	1/ - /16	811672
100		100	1/ - /16	811674	3960
300		300	1/ - /16	811676	4130
40A & 63A	30	30	1/ - /16	811673	4248
	100	100	1/ - /16	811675	4620
	300	300	1/ - /16	811677	4982

—optipro— **ACCESSORIES**

HSN Code: 8538

- Conforms to IEC 60947 - 5 - 1 • Retro Fit Type Clip On Accessory • CE Marked
- Upto Three Number of Accessory on a Modular Device • Common Accessories for Entire Range • Easy To Install

	Item Description	Pack	Cat. Nos.	Unit Price (₹)
	Auxiliary Changeover Switch 1NC	1	811580	414
	Fault Signalling Contact 1NC	1	811581	980
	Shunt Trip 12V to 48V AC/DC	1	811582	1686
	Shunt Trip 110V to 415V AC	1	811583	1686
	Undervoltage 24V & 48V AC/DC	1	811584	1472
	Undervoltage 240V AC	1	811585	1472

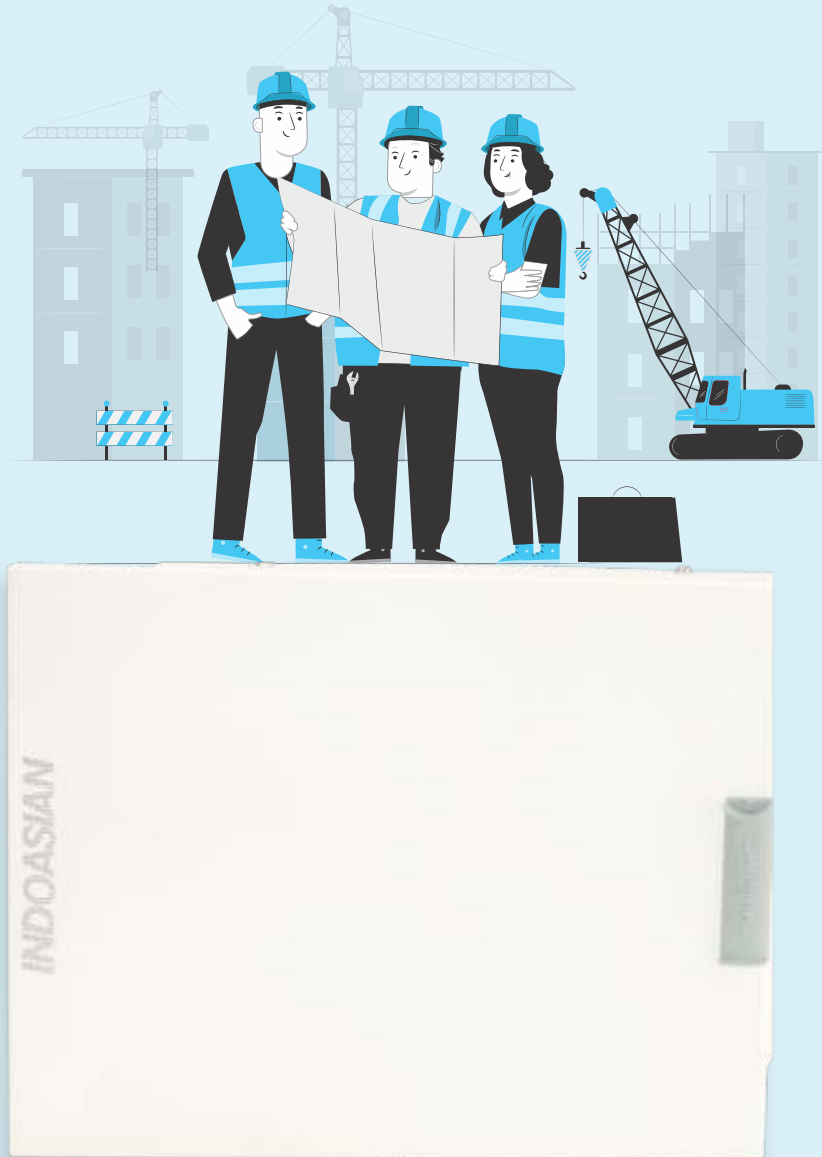

DISTRIBUTION BOARDS SUITABLE FOR MIVAN CONSTRUCTION



IP:43 protection



Increased sheet thickness to withstand the concrete pressure



Mechanical impact strength IK09

— optipro™ —

ALL THAT YOU NEED

— optipro™ — **DISTRIBUTION BOARDS (DBs)**

SPN DB-SINGLE DOOR

HSN Code: 8537

- IP : 30 Protection
- Door Earthing
- Isolated Neutral Bar
- Mechanical Impact Strength IK 08
- Cement Spill Protector

	Ways	Modules	Cat Ref.	Unit Price (₹)
	4	4	811800	1340
	6	6	811801	1400
	8	8	811802	1640
	12	12	811803	1920
	16	16	811804	2400

SPN DB-DOUBLE DOOR

HSN Code: 8537

- IP : 43 Protection
- Door Earthing
- Isolated Neutral Bar
- Mechanical Impact Strength IK 09
- Cement Spill Protector

	Ways	Modules	Cat Ref.	Unit Price (₹)
	4	4	811805	2000
	6	6	811806	2160
	8	8	811807	2240
	10	10	811812	2560
	12	12	811808	2700
	14	14	811810	2960
	16	16	811809	3280
	18	18	811811	3600

SPN DB -DOUBLE DOOR

HSN Code: 8537

- IP : 54 Protection
- Door Earthing
- Isolated Neutral Bar
- Mechanical Impact Strength IK 09
- Cement Spill Protector

	Ways	Modules	Cat Ref.	Unit Price (₹)
	4	4	811824	3080
	6	6	811825	3760
	8	8	811826	4020
	12	12	811828	5200
16	16	811829	6420	

SPN DB-ACRYLIC DOOR

HSN Code: 8537

- IP : 43 Protection
- Door Earthing
- Isolated Neutral Bar
- Cement Spill Protector

	Ways	Modules	Cat Ref.	Unit Price (₹)
	4	4	811816	2100
	6	6	811817	2500
	8	8	811818	2640
	12	12	811819	3240
16	16	811820	4000	

— optipro™ — **DISTRIBUTION BOARDS (DBs)**

TPN DB-SINGLE DOOR

HSN Code: 8537

- IP : 30 Protection
- Door Earthing
- Isolated Neutral Bar
- Mechanical Impact Strength IK 08
- Cement Spill Protector



Ways	Modules	Cat Ref.	Unit Price (₹)
4 Way compact	4+12	811832	3340
4 Way	8+12	811833	3520
6 Way compact	4+18	811834	4080
6 Way	8+18	811835	4360
8 Way	8+24	811836	5160
12 Way	8+36	811837	7420
16 Way	8+48	811838	9140

TPN DB-DOUBLE DOOR

HSN Code: 8537

- IP : 43 Protection
- Door Earthing
- Isolated Neutral Bar
- Mechanical Impact Strength IK 09
- Cement Spill Protector



Ways	Modules	Cat Ref.	Unit Price (₹)
4 Way compact	4+12	811840	4140
4 Way	8+12	811841	4340
6 Way compact	4+18	811842	5100
6 Way	8+18	811843	5420
8 Way	8+24	811844	6500
12 Way	8+36	811845	9740
16 Way	8+48	811846	12100

TPN DB -DOUBLE DOOR

HSN Code: 8537

- IP : 54 Protection
- Door Earthing
- Isolated Neutral Bar
- Mechanical Impact Strength IK 09
- Cement Spill Protector



Ways	Modules	Cat Ref.	Unit Price (₹)
4 Way compact	4+12	811856	7720
4 Way	8+12	811857	8720
6 Way compact	4+18	811858	10000
6 Way	8+18	811859	10900
8 Way	8+24	811860	13540
12 Way	8+36	811861	19240
16 Way	8+48	811862	23000

TPN DB-ACRYLIC DOOR

HSN Code: 8537

- IP : 43 Protection
- Door Earthing
- Isolated Neutral Bar
- Cement Spill Protector



Ways	Modules	Cat Ref.	Unit Price (₹)
4 Way compact	4+12	811848	5180
4 Way	8+12	811849	5640
6 Way compact	4+18	811850	6560
6 Way	8+18	811851	7040
8 Way	8+24	811852	8760
12 Way	8+36	811853	12400
16 Way	8+48	811854	14980

— optipro™ — **DISTRIBUTION BOARDS (DBs)**

VTPN MCB DB-SINGLE DOOR

HSN Code: 8537

- IP : 30 Protection
- Door Earthing
- Isolated Neutral Bar
- Mechanical Impact Strength IK 08
- Insulated busbar assembly

	Ways	Modules	Cat Ref.	Unit Price (₹)
	4 Way	8 + 12	811864	9540
	6 Way	8 + 18	811865	10480
	8 Way	8 + 24	811866	11660
	12 Way	8 + 36	811867	15680

VTPN MCB DB-DOUBLE DOOR

- IP : 43 Protection
- Door Earthing
- Isolated Neutral Bar
- Mechanical Impact Strength IK 09
- Insulated busbar assembly

	Ways	Modules	Cat Ref.	Unit Price (₹)
	4 Way	8 + 12	811870	10720
	6 Way	8 + 18	811871	12740
	8 Way	8 + 24	811872	13980
	12 Way	8 + 36	811873	17900

VTPN MCB DB -DOUBLE DOOR

HSN Code: 8537

- IP : 54 Protection
- Door Earthing
- Isolated Neutral Bar
- Mechanical Impact Strength IK 09
- Cement Spill Protector

	Ways	Modules	Cat Ref.	Unit Price (₹)
	4 Way	8 + 12	811882	16320
	6 Way	8 + 18	811883	20620
	8 Way	8 + 24	811884	25080
	12 Way	8 + 36	811885	31540

VTPN MCCB 125A DB-DOUBLE DOOR

HSN Code: 8537

- IP : 43 Protection
- Door Earthing
- Isolated Neutral Bar
- Mechanical Impact Strength IK 09
- Insulated busbar assembly
- Suitable for MCCB's upto 125A as I/C (Frame1)

	Ways	Modules	Cat Ref.	Unit Price (₹)
	4 Way	Optium F1 + 12	811888	12540
	6 Way	Optium F1 + 18	811889	14180
	8 Way	Optium F1 + 24	811890	15480
	12 Way	Optium F1 + 36	811891	21080

VTPN MCCB 125A DB -DOUBLE DOOR

HSN Code: 8537

- IP : 54 Protection
- Door Earthing
- Isolated Neutral Bar
- Mechanical Impact Strength IK 09
- Cement Spill Protector
- Suitable for MCCB's upto 125A as I/C (Frame1)

	Ways	Modules	Cat Ref.	Unit Price (₹)
	4 Way	Optium F1 + 12	812040	21020
	6 Way	Optium F1 + 18	812041	23780
	8 Way	Optium F1 + 24	812042	25440
	12 Way	Optium F1 + 36	812043	34300

— optipro™ — **DISTRIBUTION BOARDS (DBs)**

VTPN MCCB 250A DB-DOUBLE DOOR

HSN Code: 8537

- IP : 43 Protection
- Door Earthing
- Isolated Neutral Bar
- Mechanical Impact Strength IK 09
- Insulated busbar assembly
- Suitable for MCCB's upto 250A as I/C (Frame 2)

	Ways	Modules	Cat Ref.	Unit Price (₹)
	4 Way	Optium F2+ 12	811893	17580
	6 Way	Optium F2+ 18	811894	18680
	8 Way	Optium F2+ 24	811895	20660
	12 Way	Optium F2+ 36	811896	26280

VTPN MCCB 250A DB -DOUBLE DOOR

HSN Code: 8537

- IP : 54 Protection
- Door Earthing
- Isolated Neutral Bar
- Mechanical Impact Strength IK 09
- Cement Spill Protector
- Suitable for MCCB's upto 250A as I/C (Frame 2)

	Ways	Modules	Cat Ref.	Unit Price (₹)
	4 Way	Optium F2+ 12	812045	34100
	6 Way	Optium F2+ 18	812046	36380
	8 Way	Optium F2+ 24	812047	40220
	12 Way	Optium F2+ 36	812048	45180

FLEXI DB-DOUBLE DOOR

HSN Code: 8537

- IP : 43 Protection
- Door Earthing
- Isolated Neutral Bar
- Mechanical Impact Strength IK 09
- Cement Spill Protector

	Ways	Modules	Cat Ref.	Unit Price (₹)
	14 X 2 Row	28	811912	5660
	14 X 3 Row	42	811913	6740
	14 X 4 Row	56	811915	7480

FLEXI DB -DOUBLE DOOR

HSN Code: 8537

- IP : 54 Protection
- Door Earthing
- Isolated Neutral Bar
- Mechanical Impact Strength IK 09
- Cement Spill Protector

	Ways	Modules	Cat Ref.	Unit Price (₹)
	14 X 2 Row	28	812030	9120
	14 X 3 Row	42	812031	11120
	14 X 4 Row	56	812033	12260

— optipro™ — DISTRIBUTION BOARDS (DBs)

7 SEGMENT DB-DOUBLE DOOR

HSN Code: 8537

- IP : 43 Protection
- Door Earthing
- Isolated Neutral Bar
- Mechanical Impact Strength IK 09
- Compartmentalized solution

	Ways	Modules	Cat Ref.	Unit Price (₹)
	4 Way	8 + 12 + 12	811925	11080
	6 Way	8 + 12 + 18	811926	12420
	8 Way	8 + 12 + 24	811927	14000
	12 Way	8 + 12 + 36	811928	17320
	16 Way	8 + 12 + 48	811929	17800

PHASE SELECTOR DB 40A DOUBLE DOOR

HSN Code: 8537

- IP : 43 Protection
- Door Earthing
- 40 A prefitted selector switch
- Mechanical Impact Strength IK 09
- Isolated Neutral Bar

	Ways	Modules	Cat Ref.	Unit Price (₹)
	4 Way	8 + 12	811940	13120
	6 Way	8 + 18	811941	13700
	8 Way	8 + 24	811942	14860
	12 Way	8 + 36	811943	16480

PHASE SELECTOR DB 63A DOUBLE DOOR

HSN Code: 8537

- IP : 43 Protection
- Door Earthing
- 63 A prefitted selector switch
- Mechanical Impact Strength IK 09
- Isolated Neutral Bar

	Ways	Modules	Cat Ref.	Unit Price (₹)
	4 Way	8 + 12	811950	15140
	6 Way	8 + 18	811951	15800
	8 Way	8 + 24	811952	16660
	12 Way	8 + 36	811953	18740

METAL CLAD P&S

HSN Code: 8537

- IP : 30 Protection
- Without MCBs
- Mechanical Impact Strength IK 08

	Ways	Modules	Cat Ref.	Unit Price (₹)
	20A 2P+E	1 Mod	811955	1480
	20A 2P+E	2 Mod	811956	1480
	20A 3P+E	3 Mod	811957	3280
	32A 3P+E	3 Mod	811958	3900

— optipro™ — **DISTRIBUTION BOARDS (DBs)**

TV/TEL DB

HSN Code: 8537

- IP : 43 Protection
- Door Earthing

- Factory fitted KRONE type TV & TEL socket
- Mechanical Impact Strength IK 09

- Isolated & Shrouded Neutral Bar

	Ways	Modules	Cat Ref.	Unit Price (₹)
	8 Way SPN	8	811963	4420
12 Way SPN	12	811964	4980	
16 Way SPN	16	811965	5680	
4 Way TPN	8+12	811967	7360	
6 Way TPN	8+18	811983	8280	
8 Way TPN	8+24	811968	9280	

PPI DB-DOUBLE DOOR

HSN Code: 8537

- IP : 43 Protection
- Door Earthing

- Isolated Neutral Bar for individual phase
- Mechanical Impact Strength IK 09

- Cement Spill Protector

	Ways	Modules	Cat Ref.	Unit Price (₹)
	Hori 4+2 Way	8+6+12	811971	7560
Hori 6+2 Way	8+6+18	811972	9280	
Hori 8+2 Way	8+6+24	811973	10980	
Hori 12+2 Way	8+6+36	811998	13524	
Tier 6+2 Way	8+6+18	811974	8980	
Tier 8+2 Way	8+6+24	811975	11200	
Tier 12+2 Way	8+6+36	811976	13340	

PPI DB-DOUBLE DOOR

HSN Code: 8537

- IP :54 Protection
- Door Earthing

- Isolated Neutral Bar
- Mechanical Impact Strength IK 09

- Cement Spill Protector

	Ways	Modules	Cat Ref.	Unit Price (₹)
	Hori 4+2 Way	8+6+12	812034	14420
Hori 6+2 Way	8+6+18	812035	17680	
Hori 8+2 Way	8+6+24	812036	20040	
Tier 6+2 Way	8+6+18	812037	14620	
Tier 8+2 Way	8+6+24	812038	18260	
Tier 12+2 Way	8+6+36	812039	21240	

PLASTIC P&S

HSN Code: 8537

- IP : 30 Protection

- Without MCBs

	Ways	Modules	Cat Ref.	Unit Price (₹)
	16A 2P+E	2 Mod	811959	2980
32A 2P+E	2 Mod	811960	3060	
32A 3P+N+E	4 Mod	811961	4900	
63A 3P+N+E	4 Mod	811962	12920	

— optipro™ — DISTRIBUTION BOARDS (DBs)

ENCLOSURES

HSN Code: 8537

	Ways	Modules	Cat Ref.	Unit Price (₹)
	1/2 Mod plastic	2	811977	200
	3/4 Mod plastic	4	811978	340
	1 Mod metal	1	811979	500
	2 Mod metal	2	811980	500
	3 Mod metal	3	811981	660
	4 Mod metal	4	811982	660

CABLE END BOX

HSN Code: 8537

- IP : 43 Protection
- Mechanical Impact Strength IK08

Description	Cat Ref.	Unit Price (₹)
CEB SPN DD 4W DB	812000	880
CEB SPN DD 6W DB	812001	940
CEB SPN DD 8W DB	812002	1000
CEB SPN DD 10W DB	812003	1120
CEB SPN DD 12W DB	812004	1180
CEB SPN DD 14W DB	812005	1260
CEB SPN DD 16W DB	812006	1420
CEB SPN DD 18W DB	812007	1520
CEB TPN DD 4W 4 POLE I/C DB	812008	1080
CEB TPN DD 4W 8 POLE I/C DB or CEB TPN 6W4P I/C DB	812009	1300
CEB TPN DD 6W 8P I/C DB or PPI HORI. DD DB 4+2W	812010	1540
CEB TPN DD 8W DB or PPI HORI. DD DB 6+2W	812011	1900
CEB TPN DD 10W DB or PPI HORI. DD DB 8+2W	812012	2220
CEB TPN DD 12W DB	812013	2600
CEB TPN DD 16W DB	812014	2660
CEB VTPN MCB I/C DB or VTPN MCCB I/C DD DB	812015	2080
CEB FLEXY DD 14 MOD. PER ROW DB	812017	1880
CEB PPI TIER 6+2W	812018	1860
CEB PPI TIER 8+2W	812019	2200
CEB PPI TIER 12+2W	812020	2320

MCCB ENCLOSURE

- Solid Neutral Link for 3 Pole MCCBs

Description	Pack	Cat. Nos.	Unit Price (₹)
Optipro Enclosure for Frame-1 Optium 3 Pole MCCB	1	811984	1820
Optipro Enclosure for Frame-1 Optium 4 Pole MCCB	1	811985	1820
Optipro Enclosure for Frame-2 Optium 3 Pole MCCB	1	811986	2820
Optipro Enclosure for Frame-2 Optium 4 Pole MCCB	1	811987	2820
Optipro Enclosure for Frame-3 Optium 3 Pole MCCB	1	811988	2820
Optipro Enclosure for Frame-3 Optium 4 Pole MCCB	1	811989	2820
Optipro Enclosure for Frame-4 Optium 3 Pole MCCB	1	811990	7020
Optipro Enclosure for Frame-4 Optium 4 Pole MCCB	1	811991	7020

**BUSBAR CHAMBER
TPN BBC (Cu-Busbar)**

HSN Code: 8536

	<p>Solution for safe Power Distribution</p> <ul style="list-style-type: none"> • Step type design • Available in both SPN & TPN configuration 	Item Description	Ingress Protection *	Cat Ref.	Unit Price* (₹)
		Spl. 32A TPN BBC (Cu) with 4 o/g ways	IP42	CPPI1015	7324
		Spl. 63A TPN BBC (Cu) with 4 o/g ways	IP42	CPPI1016	8170
		Spl. 100A TPN BBC (Cu) with 4 o/g ways	IP42	CPPI1017	9050
		Spl. 200A TPN BBC (Cu) with 4 o/g ways	IP42	CPPI1018	11194
		Spl. 250A TPN BBC (Cu) with 4 o/g ways	IP42	CPPI1019	15934
		Spl. 320A TPN BBC (Cu) with 4 o/g ways	IP42	CPPI1020	19358
		Spl. 400A TPN BBC (Cu) with 4 o/g ways	IP42	CPPI1021	21508
		Spl. 630A TPN BBC (Cu) with 4 o/g ways	IP42	CPPI1022	34410

*Also available in IP54 design

**BUSBAR CHAMBER
TPN-Type (Al.Busbar)**

HSN Code: 8536

	<p>Solution for safe Power Distribution</p> <ul style="list-style-type: none"> • Step type design • Available in both SPN & TPN configuration 	Item Description	Ingress Protection *	Cat Ref.	Unit Price* (₹)
		Spl. 32A TPN BBC (Al.) with 4 o/g ways	IP42	CPPI1023	6884
		Spl. 63A TPN BBC (Al.) with 4 o/g ways	IP42	CPPI1024	7324
		Spl. 100A TPN BBC (Al.) with 4 o/g ways	IP42	CPPI1025	7728
		Spl. 200A TPN BBC (Al.) with 4 o/g ways	IP42	CPPI1026	8170
		Spl. 250A TPN BBC (Al.) with 4 o/g ways	IP42	CPPI1027	9874
		Spl. 320A TPN BBC (Al.) with 4 o/g ways	IP42	CPPI1028	10754
		Spl. 400A TPN BBC (Al.) with 4 o/g ways	IP42	CPPI1029	11194
		Spl. 630A TPN BBC (Al.) with 4 o/g ways	IP42	CPPI1008	19240

*Also available in IP54 design

**METAL CLAD PLUG & SOCKET
AC PLUG**

HSN Code: 8536

	Rating	Pack	Cat. Nos.	Unit Price (₹)
	10A 2P+E, 230V AC	1/10/100	810385	170
	20A 2P+E, 230V AC	1/10/100	810386	182
	20A 3P+E, 230V / 415V AC	1/10/100	810387	246
	32A 3P+E, 230V / 415V AC	1/10/100	810388	446

AC SOCKET

HSN Code: 8536

	Rating	Pack	Cat. Nos.	Unit Price (₹)
	10A 2P+E, 230V AC	1/10/100	810389	170
	20A 2P+E, 230V AC	1/10/100	810390	194
	20A 3P+E, 230V / 415V AC	1/10/100	810391	258
	32A 3P+E, 230V / 415V AC	1/10/100	810392	446

TIME SWITCHES

ANALOG TIME SWITCHES (with battery back up)

HSN Code: 9107

	Model Name	Description	Cat Ref.	Unit Price (₹)
	1mod DIN Daily	1P Module, 24 hours program, Programmable every 15 min., backup of 100 hours, current capacity 16A, with 1 changeover (1 CO)	TA916422	3612
	3mod DIN Daily	3P Module, 24 hours program, Programmable every 15 min., backup of 100 hrs., current capacity 16A, with 1 changeover (1 CO)	TA926453	3934
	Front Mounted Daily	Front Mounting, 24 hours program, Programmable every 20 min., back up of 100 hrs., current capacity 16A, with 1 changeover (1 CO)	TA912472*	3612
	3mod DIN Weekly	Weekly program, Programmable every 4 hrs., with back up of 100 hrs., current capacity 16A, with 1 changeover (1 CO)	TA926129*	4298

*Discontinued product, available till stock lasts.

ANALOG TIME SWITCHES (without battery back up)

HSN Code: 9107

	Model Name	Description	Cat Ref.	Unit Price (₹)
	3mod DIN Daily	3P Module, 24 hours program, Programmable every 15 min., current capacity 16A, with 1 changeover (1 CO)	TA925450*	3320
	Front Mounted Daily	Front Mounting, 24 hours program, Programmable every 20 min., current capacity 16A, with 1 changeover (1 CO)	TA912473*	2988

*Discontinued product, available till stock lasts.

DIGITAL TIME SWITCHES

HSN Code: 9107

	Model Name	Description	Cat Ref.	Unit Price (₹)
	DIN Type Daily / Weekly with 1 CO	Programmable every 1 min., with backup of 6 years, 28 memory locations, current capacity 16A, weekly program, with 1 changeover (1 CO), Total 28 programs	TDA43110	4780
	DIN Type Daily / Weekly with 2 CO	Programmable every 1 min., with backup of 6 years, 28 memory locations, current capacity 16A, weekly program, with 2 changeover (2 CO), Total 14 programs per channel	TDA43111	7176
	DIN Type Astronomical with 1 CO	Astronomical Programmable every 1 min., backup of 6 years, 28 memory locations, current capacity 16A, with 1 changeover (1 CO), Total 28 programs	TDA45163	9952
	DIN Type Astronomical with 2 CO	Astronomical Programmable every 1 min., backup of 6 years, 28 memory locations, current capacity 16A, with 2 changeover (2 CO), Total 14 programs per channel	TDA45164	12436

LIGHT SENSITIVE SWITCHES

HSN Code: 9107

	Model Name	Description	Cat Ref.	Unit Price (₹)
	1mod DIN Light Sensitive	Light sensitive switch with outer sensor, sensitive distance 50m, current capacity 16A & control from 1 lux to 100K lux.	TSA58107	8294

TIMELITE DISTRIBUTION BOARDS

HSN Code: 8537

	Description	Cat Ref.	Unit Price (₹)
	Timelite-16A 3Pole/230V-Analog Time switch	TL016AB0	23326
	Timelite-32A 3Pole/230V-Analog Time switch	TL032AB0	25232
	Timelite-32A 3Pole/230V-Digital Time Switch	TL032DB0	27538
	Timelite-32A 3Pole/230V-Astronomical Time Switch	TL032AS0	32136
	Timelite-40A 3Pole/230V-Analog Time Switch	TL040AB0	27180
	Timelite-40A 3Pole/230V-Digital Time Switch	TL040DB0	29438
	Timelite-40A 3Pole/230V-Astronomical Time Switch	TL040AS0	34040
	Timelite-65A 3Pole/230V-Analog Time Switch	TL065AB0	34794
	Timelite-65A 3Pole/230V-Digital Time Switch	TL065DB0	37094
	Timelite-65A 3Pole/230V-Astronomical Time Switch	TL065AS0	41672
	Timelite-110A 3Pole/230V-Analog Time Switch	TL110AB0	58250
	Timelite-110A 3Pole/230V-Digital Time Switch	TL110DB0	60024
	Timelite-110A 3Pole/230V-Astronomical Time Switch	TL110AS0	65222
The analog time switch which will be used in Timelite DBs is TA926453 The digital time switch which will be used in Timelite DBs is TDA43110 The astronomical time switch which will be used in Timelite DBs is TDA45163			

GSM based SMART Timelite DB's are also available on request.

AUTOMATIC CHANGEOVER WITH CURRENT LIMITER

- As per IEC60947-6-1
- Intelligent micro controller based Design
- RoHS Compliant

HSN Code: 8536

	Rating (A)	Pack	Cat. Nos.	Unit Price (₹)
	SPN 30A Mains 1.5A DG ACCL	1/3/45	810409	1970
	SPN 30A Mains 2.5A DG ACCL	1/3/45	810410	1970
	SPN 30A Mains 3A DG ACCL	1/3/45	810400	1970
	SPN 30A Mains 4A DG ACCL	1/3/45	810401	1970
	SPN 30A Mains 5A DG ACCL	1/3/45	810402	1970
	SPN 30A Mains 6A DG ACCL	1/3/45	810403	1970
	SPN 30A Mains 9A DG ACCL	1/3/45	810404	1970
	SPN 30A Mains 12A DG ACCL	1/3/45	810405	1970
	SPN 30A Mains 15A DG ACCL	1/3/45	810406	1970
	SPN 30A Mains 20A DG ACCL	1/3/45	810407	1970
	SPN 30A Mains 30A DG ACCL	1/3/45	810408	1970

—optium™— **OPTIUM 1.0E (FIXED TM MCCB RANGE)**

- Ics =50% Icu as per IEC 60947-II
- Suitable for isolation
- Class II front face
- Fixed Overload & fixed short circuit setting

HSN Code: 8536

	Frame	Breaking capacity	Rating	3P	Unit Price (₹)	4P	Unit Price (₹)
		F1	10kA	16	830701	2562	830710
	F1	10kA	25	830702	2562	830711	3110
	F1	10kA	32	830703	2562	830712	3110
	F1	10kA	40	830704	2562	830713	3110
	F1	10kA	50	830705	2562	830714	3110
	F1	10kA	63	830706	2562	830715	3110
	F1	10kA	80	830707	2886	830716	3694
	F1	10kA	100	830708	2886	830717	3694
	F1	10kA	125	830709	4136	830718	5344

HSN Code: 8536

	Frame	Breaking capacity	Rating	3P	Unit Price (₹)	4P	Unit Price (₹)
		F1	16kA	16	830001	4266	830015
	F1	16kA	25	830002	4266	830016	5210
	F1	16kA	32	830003	4266	830017	5210
	F1	16kA	40	830004	4266	830018	5210
	F1	16kA	50	830005	4266	830019	5210
	F1	16kA	63	830006	4266	830020	5210
	F1	16kA	80	830007	4478	830021	5768
	F1	16kA	100	830008	4478	830022	5768
	F1	16kA	125	830009	6206	830023	8158

HSN Code: 8536

	Frame	Breaking capacity	Rating	3P	Unit Price (₹)	4P	Unit Price (₹)
		F1	25kA	16	830031	5134	830045
	F1	25kA	25	830032	5134	830046	6136
	F1	25kA	32	830033	5134	830047	6136
	F1	25kA	40	830034	5134	830048	6136
	F1	25kA	50	830035	5134	830049	6136
	F1	25kA	63	830036	5134	830050	6136
	F1	25kA	80	830037	5286	830051	6442
	F1	25kA	100	830038	5286	830052	6442
	F1	25kA	125	830039	6366	830053	8474

HSN Code: 8536

	Frame	Breaking capacity	Rating	3P	Unit Price (₹)	4P	Unit Price (₹)
		F1	36kA	16	830061	6796	830075
	F1	36kA	25	830062	6796	830076	7774
	F1	36kA	32	830063	6796	830077	7774
	F1	36kA	40	830064	6796	830078	7774
	F1	36kA	50	830065	6796	830079	7774
	F1	36kA	63	830066	6796	830080	7774
	F1	36kA	80	830067	6900	830081	8192
	F1	36kA	100	830068	6900	830082	8192
	F1	36kA	125	830069	9508	830083	9882

—optium™— **OPTIUM 1.0 (FIXED TM MCCB RANGE)**

HSN Code: 8536

	Frame	Breaking capacity	Rating	3P	Unit Price (₹)	4P	Unit Price (₹)
	F3	50kA	16	830125	8208	830145	9978
	F3	50kA	25	830126	8208	830146	9978
	F3	50kA	32	830127	8208	830147	9978
	F3	50kA	40	830128	8208	830148	9978
	F3	50kA	50	830129	8208	830149	9978
	F3	50kA	63	830130	8208	830150	9978
	F3	50kA	80	830131	8622	830151	10280
	F3	50kA	100	830132	8622	830152	10280
	F3	50kA	125	830133	10058	830153	12754

HSN Code: 8536

	Frame	Breaking capacity	Rating	3P	Unit Price (₹)	4P	Unit Price (₹)
	F2	16kA	160	830090	6724	830095	9708
	F2	16kA	200	830091	8662	830096	11276
	F2	16kA	250	830092	9558	830097	11910
	F2	25kA	160	830100	7922	830105	9964
	F2	25kA	200	830101	10956	830106	13254
	F2	25kA	250	830102	14136	830107	16618
	F2	36kA	160	830110	9976	830115	12226
	F2	36kA	200	830111	12778	830116	16146
F2	36kA	250	830112	16680	830117	21936	

HSN Code: 8536

	Frame	Breaking capacity	Rating	3P	Unit Price (₹)	4P	Unit Price (₹)
	F3	50kA	160	830134	11252	830154	15450
	F3	50kA	200	830135	13542	830155	19012
F3	50kA	250	830136	17418	830156	23138	

HSN Code: 8536

	Frame	Breaking capacity	Rating	3P	Unit Price (₹)	4P	Unit Price (₹)
	F4	36kA	315	830165	22742	830175	25946
	F4	36kA	400	830166	24036	830176	27420
	F4	36kA	500	830167	26896	830177	31124
F4	36kA	630	830168	28508	830178	32760	

HSN Code: 8536

	Frame	Breaking capacity	Rating	3P	Unit Price (₹)	4P	Unit Price (₹)
	F4	50kA	315	830185	23410	830195	27756
	F4	50kA	400	830186	25550	830196	29980
	F4	50kA	500	830187	27780	830197	32222
F4	50kA	630	830188	29448	830198	33388	

HSN Code: 8536

	Frame	Breaking capacity	Rating	3P	MRP	4P	MRP
F5	50kA	800	830200	37998	830201	49082	

—optium™— **OPTIUM 1.1 (FIXED TM MCCB RANGE)**

- Ics = 100% Icu as per IEC 60947-II
- Suitable for isolation
- Class II front face
- Fixed Overload & fixed short circuit setting

HSN Code: 8536

NEW



Frame	Breaking capacity	Rating	3P	Unit Price (₹)	4P	Unit Price (₹)
F1	16kA	32	840003	4440	840017	5826
F1	16kA	40	840004	4440	840018	5826
F1	16kA	63	840006	4440	840020	5826
F1	16kA	80	840007	4614	840021	6232
F1	16kA	100	840008	4614	840022	6232
F1	16kA	125	840009	6472	840023	8698
F1	25kA	32	840033	5386	840047	6824
F1	25kA	40	840034	5386	840048	6824
F1	25kA	63	840036	5386	840050	6824
F1	25kA	80	840037	5708	840051	6956
F1	25kA	100	840038	5708	840052	6956
F1	25kA	125	840039	6604	840053	9758
F2	16kA	160	840090	7074	840095	10546
F2	16kA	200	840091	8880	840096	11788
F2	16kA	250	840092	10122	840097	13512
F2	25kA	160	840100	8234	840105	10880
F2	25kA	200	840101	11218	840106	13884
F2	25kA	250	840102	14936	840107	18122

—optium™— **OPTIUM 2.0 (ADJUSTABLE THERMAL SETTING MCCB)**

- Conforms to IEC 60947-II
- Adjustable Overload Setting $I_r = (0.8 \text{ to } 1.0) \times I_n$
- Ics = 100% Icu
- Class II front face
- Suitable for isolation
- Short Circuit setting fixed

HSN Code: 8536



Frame	Breaking capacity	Rating	3P	Unit Price (₹)	4P	Unit Price (₹)
F1	16kA	25	830222	4518	830236	6032
F1	16kA	32	830223	4518	830237	6032
F1	16kA	40	830224	4518	830238	6032
F1	16kA	50	830225	4518	830239	6032
F1	16kA	63	830226	4518	830240	6032
F1	16kA	80	830227	4898	830241	6486
F1	16kA	100	830228	4898	830242	6486
F1	16kA	125	830229	6686	830243	9038

HSN Code: 8536



Frame	Breaking capacity	Rating	3P	Unit Price (₹)	4P	Unit Price (₹)
F1	25kA	25	830252	5666	830266	7132
F1	25kA	32	830253	5666	830267	7132
F1	25kA	40	830254	5666	830268	7132
F1	25kA	50	830255	5666	830269	7132
F1	25kA	63	830256	5666	830270	7132
F1	25kA	80	830257	5944	830271	7482
F1	25kA	100	830258	5944	830272	7482
F1	25kA	125	830259	6878	830273	10238

HSN Code: 8536



Frame	Breaking capacity	Rating	3P	Unit Price (₹)	4P	Unit Price (₹)
F2	16kA	160	830280	7420	830285	10924
F2	16kA	200	830281	9246	830286	12240
F2	16kA	250	830282	10702	830287	14462
F2	25kA	160	830290	9390	830295	12320
F2	25kA	200	830291	12020	830296	15508
F2	25kA	250	830292	16070	830297	20096

—optium™— **OPTIUM 2.0 (ADJUSTABLE TM MCCB RANGE)**

- Ics =100% Icu as per IEC 60947-II
- Adjustable Overload Setting Ir =(0.8 to 1.0)xIn
- Class II front face
- Adjustable Short Circuit Setting Isd =[5 -10]xIn
- Suitable for isolation

HSN Code: 8536

	Frame	Breaking capacity	Rating	3P	Unit Price (₹)	4P	Unit Price (₹)
		F3	36kA	16	830305	7652	830325
	F3	36kA	25	830306	7652	830326	10574
	F3	36kA	32	830307	7652	830327	10574
	F3	36kA	40	830308	7652	830328	10574
	F3	36kA	50	830309	7652	830329	10574
	F3	36kA	63	830310	7652	830330	10574
	F3	36kA	80	830311	7802	830331	10884
	F3	36kA	100	830312	7802	830332	10884
	F3	36kA	125	830313	10018	830333	12194

HSN Code: 8536

	Frame	Breaking capacity	Rating	3P	Unit Price (₹)	4P	Unit Price (₹)
		F3	50kA	16	830345	10302	830365
	F3	50kA	25	830346	10302	830366	12314
	F3	50kA	32	830347	10302	830367	12314
	F3	50kA	40	830348	10302	830368	12314
	F3	50kA	50	830349	10302	830369	12314
	F3	50kA	63	830350	10302	830370	12314
	F3	50kA	80	830351	10510	830371	12436
	F3	50kA	100	830352	10510	830372	12436
	F3	50kA	125	830353	11564	830373	14846

HSN Code: 8536

	Frame	Breaking capacity	Rating	3P	Unit Price (₹)	4P	Unit Price (₹)
		F3	36kA	160	830314	12782	830334
	F3	36kA	200	830315	14334	830335	19846
	F3	36kA	250	830316	18828	830336	25990

HSN Code: 8536

	Frame	Breaking capacity	Rating	3P	Unit Price (₹)	4P	Unit Price (₹)
		F3	50kA	160	830354	13248	830374
	F3	50kA	200	830355	15456	830375	21190
	F3	50kA	250	830356	21938	830376	27372

HSN Code: 8536

	Frame	Breaking capacity	Rating	3P	Unit Price (₹)	4P	Unit Price (₹)
		F4	25kA	315	830385	20022	830387
	F4	25kA	400	830386	20500	830388	27510
	F4	36kA	315	830390	24060	830395	29304
	F4	36kA	400	830391	25596	830396	31552
	F4	36kA	500	830392	29834	830397	36990
	F4	36kA	630	830393	32412	830398	41434
	F4	50kA	315	830400	25690	830405	31732
	F4	50kA	400	830401	27420	830406	33322
	F4	50kA	500	830402	31408	830407	39068
	F4	50kA	630	830403	33956	830408	43342

—optium™— **OPTIUM 2.0 (ADJUSTABLE TM MCCB RANGE)**

HSN Code: 8536

	Frame	Breaking capacity	Rating	3P	Unit Price (₹)	4P	Unit Price (₹)
	F5	36kA	800	830410	39216	830413	48088
F5	36kA	1000	830411	56478	830414	64604	
F5	36kA	1250	830412	65322	830415	77632	
F5	50kA	800	830416	40372	830419	57520	
F5	50kA	1000	830417	70212	830420	75292	
F5	50kA	1250	830418	77438	830421	87208	

—optium™— **OPTIUM 2.1 (ELECTRONIC / MICRO -PROCESSOR MCCB RANGE)**

- Ics =100% Icu as per IEC 60947-II
- Class II front face
- Suitable for isolation
- Adjustable Overload Setting $I_r = (0.4 - 1) \times I_n$
- Adjustable Short circuit Current Setting $I_{sd} = 1.5 - 10 \times I_r$

HSN Code: 8536

Frame	Breaking capacity	Rating	3P	Unit Price (₹)	4P	Unit Price (₹)
F3	36kA	40	830430	16294	830440	20522
F3	36kA	100	830431	16592	830441	20894
F3	36kA	160	830432	20280	830442	24382
F3	36kA	250	830433	25590	830443	31038
F3	50kA	40	830450	18220	830460	21878
F3	50kA	100	830451	19432	830461	23352
F3	50kA	160	830452	22112	830462	27038
F3	50kA	250	830453	29086	830463	35640

—optium™— **OPTIUM 2.1 (ELECTRONIC / MICRO -PROCESSOR MCCB RANGE)**

- Ics =100% Icu as per IEC 60947-II
- Class II front face
- Suitable for isolation
- Transparent cover for trip unit as standard
- Adjustable Neutral pole protection -N,N/2 & Off for 4 pole MCCB
- Innovative front indication LED's(Ready, Overload pre-alarm & Overload)
- Adjustable Overload Setting $I_r = (0.4 - 1) \times I_n$; $T_r = 3-30$ sec
- Adjustable Short circuit Current Setting $I_{sd} = (1.5 - 10) I_r$; $T_{sd} (I=K) = 0-500$ ms; $T_{sd} (I2t=K) = 0-500$ ms

HSN Code: 8536

	Frame	Breaking capacity	Rating	3P	Unit Price (₹)	4P	Unit Price (₹)
	F4	36kA	400	830510	30900	830512	40748
F4	36kA	630	830511	34818	830513	44238	
F4	50kA	400	830514	38200	830516	48580	
F4	50kA	630	830515	39562	830517	51286	

HSN Code: 8536

	Frame	Breaking capacity	Rating	3P	Unit Price (₹)	4P	Unit Price (₹)
	F5	36kA	800	830540	56492	830542	68500
F5	36kA	1250	830541	84950	830543	108224	
F5	50kA	800	830544	60310	830546	75240	
F5	50kA	1250	830545	103706	830547	143370	

—optium™— **OPTIUM 2.2 (WITH ELECTRONIC / MICRO PROCESSOR RELEASE)**

- Ics =100% Icu as per IEC 60947-II
- Class II front face
- Suitable for isolation
- Adjustable Overload Setting $I_r = (0.4 - 1) \times I_n$
- Adjustable Short circuit Current Setting $I_{sd} = (1.5 - 10) \times I_r$
- Ground fault Setting:- $I_g = (0.2 - 1) \times I_n$

HSN Code: 8536

Frame	Breaking capacity	Rating	3P	Unit Price (₹)	4P	Unit Price (₹)
F3	36kA	40	830470	19368	830480	24208
F3	36kA	100	830471	19888	830481	24856
F3	36kA	160	830472	22342	830482	27682
F3	36kA	250	830473	28550	830483	35130
F3	50kA	40	830490	21102	830500	25532
F3	50kA	100	830491	21668	830501	25870
F3	50kA	160	830492	24824	830502	30140
F3	50kA	250	830493	32270	830503	38860

—optium™— **OPTIUM 2.2 (ELECTRONIC / MICRO -PROCESSOR MCCB RANGE)**

- Ics =100% Icu as per IEC 60947-II
- Class II front face
- Suitable for isolation
- Adjustable Neutral pole protection –N,N/2 & Off for 4 pole MCCB
- Innovative front indication LED's(Ready, Overload pre-alarm & Overload)
- Adjustable Overload Setting $I_r = 0.4 - 1 \times I_n$; $T_r = 3-30$ sec
- Adjustable Short circuit Current Setting $I_{sd} = 1.5 - 10 I_r$; T_{sd} (I=K) = 0-500 ms; T_{sd} (I2t=K) = 0-500 ms
- Ground fault Setting:- $I_g = (0.2 - 1) \times I_n$; $T_g = (0.1 - 1) s$

HSN Code: 8536

	Frame	Breaking capacity	Rating	3P	Unit Price (₹)	4P	Unit Price (₹)
	F4	36kA	400	830520	41090	830522	48720
	F4	36kA	630	830521	46960	830523	59872
	F4	50kA	400	830524	46094	830526	53072
	F4	50kA	630	830525	52100	830527	66484

HSN Code: 8536

	Frame	Breaking capacity	Rating	3P	Unit Price (₹)	4P	Unit Price (₹)
	F5	36kA	800	830550	70752	830552	89374
	F5	36kA	1250	830551	94340	830553	123510
	F5	50kA	800	830554	84410	830556	103862
	F5	50kA	1250	830555	114074	830557	150480

—optium™— **ACCESSORIES**

HSN Code: 8538

	Product	Frame	Cat Ref.	Unit Price (₹)
	Auxiliary contact	F1 F2 F3	830691	1038
	Alarm Contact	F1 F2 F3	830692	1038
	Auxiliary contact / Alarm Contact	F4-F5	830693	1362
	Auxiliary contact / Alarm Contact	F1 F2 F3	830694	1556

HSN Code: 8538

	Product	Frame	Cat Ref.	Unit Price (₹)
	"Shunt trip 24 V AC/DC"	F1 F2 F3	830602	1176
	"Shunt trip 110 V AC/DC"	F1 F2 F3	830603	1176
	"Shunt trip 230 V AC/DC"	F1 F2 F3	830604	1258
	"Shunt trip 415 V AC/DC"	F1 F2 F3	830605	1258
	"Shunt trip 24 V AC/DC"	F4 F5	830642	2312
	"Shunt trip 110 V AC/DC"	F4 F5	830643	2312
	"Shunt trip 230 V AC/DC"	F4 F5	830644	2312
	"Shunt trip 415 V AC/DC"	F4 F5	830645	2312

HSN Code: 8538

	Product	Frame	Cat Ref.	Unit Price (₹)
	"Undervoltage 24 V DC"	F1 F2 F3	830606	1928
	"Undervoltage 110V AC"	F1 F2 F3	830607	1928
	"Undervoltage 230V AC"	F1 F2 F3	830608	1928
	"Undervoltage 415V AC"	F1 F2 F3	830609	1928
	"Undervoltage 24 V DC"	F4 F5	830646	2054
	"Undervoltage 110V AC"	F4 F5	830647	2054
	"Undervoltage 230V AC"	F4 F5	830648	2054
	"Undervoltage 415V AC"	F4 F5	830649	2054

—optium™— **ACCESSORIES**

HSN Code: 8538



Product	Frame	Cat Ref.	Unit Price (₹)
Rotary Handle Direct	F1	830611	1476
Rotary Handle vary-Depth	F1	830612	1476
Rotary Handle Direct	F2 F3	830626	1734
Rotary Handle vary-Depth	F2 F3	830627	1734
Rotary Handle Direct	F4	830651	2054
Rotary Handle vary-Depth	F4	830652	2054
Rotary Handle Direct	F5	830671	4024
Rotary Handle vary-Depth	F5	830672	4024

HSN Code: 8538



Product	Frame	Cat Ref.	Unit Price (₹)
Ronis lock Direct RH	F1 F2 F3	830613	1618
Ronis lock Vary-Depth RH	F1 F2 F3	830614	1618
Ronis lock Vary-Depth RH	F4	830653	2182

HSN Code: 8538



Product	Frame	Cat Ref.	Unit Price (₹)
Padlock Off position	F1 F2 F3	830615	2204
Padlock Off position	F4	830654	2204
Padlock Off position	F5	830674	2204

HSN Code: 8538



Product	Frame	Cat Ref.	Unit Price (₹)
Phase insulators 3P	F1 F2	830616	POR
Phase insulators 3P	F3	830628	POR
Phase insulators 3P	F4	830655	POR
Phase insulators 3P	F5	830675	POR
Phase insulators 4P	F1 F2	830617	POR
Phase insulators 4P	F3	830629	POR
Phase insulators 4P	F4	830656	POR
Phase insulators 4P	F5	830676	POR

HSN Code: 8538



Product	Frame	Cat Ref.	Unit Price (₹)
Terminal cover 3P	F4	830657	POR
Terminal cover 3P	F5	830677	POR
Terminal cover 4P	F4	830658	POR
Terminal cover 4P	F5	830678	POR
Terminal shield 3P	F5	830679	POR
Terminal shield 4P	F5	830680	POR

—optium™— **ACCESSORIES**

HSN Code: 8538

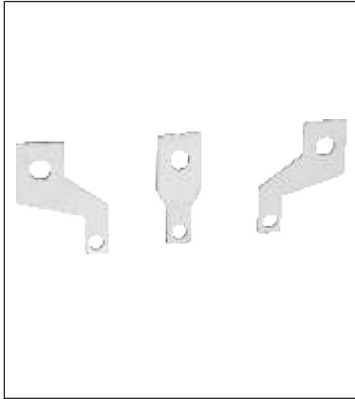

Product	Frame	Cat Ref.	Unit Price (₹)
Spreaders 3P	F1	830618	398
Spreaders 4P	F1	830619	580
Spreaders 3P	F2 F3	830632	1058
Spreaders 4P	F2 F3	830633	2116
Spreaders 3P	F4	830659	3386
Spreaders 4P	F4	830660	4938
Spreaders 3P 800/1000A	F5	830681	8746
Spreaders 4P 800/1000A	F5	830682	12824
Spreaders 3P 1250A	F5	830685	9096
Spreaders 4P 1250A	F5	830686	13408

HSN Code: 8538



Product	Frame	Cat Ref.	Unit Price (₹)
Cages 3P upto 50A	F1	830620	POR
Cages 4P upto 50A	F1	830621	POR
Cages 3P 63 to 100A	F1	830622	POR
Cages 4P 63 to 100A	F1	830623	POR
Cages 3P 125A	F1	830624	POR
Cages 4P 125A	F1	830625	POR
Cages 3P	F2	830630	POR
Cages 4P	F2	830631	POR
Cages 3P	F3	830634	POR
Cages 4P	F3	830635	POR
Cages 3P	F4	830661	POR
Cages 4P	F4	830662	POR
Cages 3P	F5	830683	POR
Cages 4P	F5	830684	POR



READY TO USE-SAFE-RELIABLE SUB MAIN DISTRIBUTION BOARD



Highly reliable & tested solution as per IEC 61439-2



Easy to install



3 frame Sizes: SMDB250, SMDB400 & SMDB630



Degree of protection IP43 & IP30

—optipro[™] SMDB—

Optipro SMDB with TP MCCB as Outgoing (Single Door) SMDB 250 - Main Enclosure

HSN Code: 8536

- Tested as per IEC 61439-2
- Degree of protection IP-30 in Single door & IP-43 in Double door
- 3 Frame sizes - SMDB250, SMDB400, SMDB630
- wide range- 4W, 6W, 8W & 12W

Item Description	Type	Cat Ref.	Unit Price (₹)
SMDB250 4W SD ME Optium F2-I/c & TP F1 O/G	SD	812100	38210
SMDB250 6W SD ME Optium F2-I/c & TP F1 O/G	SD	812101	41020
SMDB250 8W SD ME Optium F2-I/c & TP F1 O/G	SD	812102	47110
SMDB250 12W SD ME Optium F2-I/c & TP F1 O/G	SD	812103	55680
SMDB250 4W SD ME Optium F3-I/c & TP F1 O/G	SD	812110	41520
SMDB250 6W SD ME Optium F3-I/c & TP F1 O/G	SD	812111	44570
SMDB250 8W SD ME Optium F3-I/c & TP F1 O/G	SD	812112	51190
SMDB250 12W SD ME Optium F3-I/c & TP F1 O/G	SD	812113	60530

Optipro SMDB with TP MCCB as Outgoing (Single Door) SMDB 400 - Main Enclosure

HSN Code: 8536

Item Description	Type	Cat Ref.	Unit Price (₹)
SMDB400 4W SD ME Optium F4-I/c & TP F1 O/G	SD	812120	42720
SMDB400 6W SD ME Optium F4-I/c & TP F1 O/G	SD	812121	45840
SMDB400 8W SD ME Optium F4-I/c & TP F1 O/G	SD	812122	52800
SMDB400 12W SD ME Optium F4-I/c & TP F1 O/G	SD	812123	62400
SMDB400 8W SD ME Optium F4-I/c & TP F1-6 & F2-2 O/G	SD	812124	52800
SMDB400 12W SD ME Optium F4-I/c & TP F1-8 & F2-4 O/G	SD	812125	62400
SMDB400 12W SD ME Optium F4-I/c & TP F1-10 & F2-2 O/G	SD	812126	62400

Optipro SMDB with TP MCCB as Outgoing (Single Door) SMDB 630 - Main Enclosure

HSN Code: 8536

Item Description	Type	Cat Ref.	Unit Price (₹)
SMDB630 4W SD ME Optium F4-I/c & TP F1 O/G	SD	812136	64080
SMDB630 6W SD ME Optium F4-I/c & TP F1 O/G	SD	812137	66480
SMDB630 8W SD ME Optium F4-I/c & TP F1 O/G	SD	812138	76560
SMDB630 12W SD ME Optium F4-I/c & TP F1 O/G	SD	812139	90480
SMDB630 8W SD ME Optium F4-I/c & TP F1-6 & F2-2 O/G	SD	812140	76560
SMDB630 12W SD ME Optium F4-I/c & TP F1-8 & F2-4 O/G	SD	812141	90480
SMDB630 12W SD ME Optium F4-I/c & TP F1-10 & F2-2 O/G	SD	812142	90480

Optipro SMDB with FP MCCB as Outgoing (Single Door) SMDB 250 - Main Enclosure

HSN Code: 8536

Item Description	Type	Cat Ref.	Unit Price (₹)
SMDB250 4W SD ME Optium F2-I/c & FP F1 O/G	SD	812105	42020
SMDB250 6W SD ME Optium F2-I/c & FP F1 O/G	SD	812105	45100
SMDB250 8W SD ME Optium F2-I/c & FP F1 O/G	SD	812105	51840
SMDB250 12W SD ME Optium F2-I/c & FP F1 O/G	SD	812105	61440
SMDB250 4W SD ME Optium F3-I/c & FP F1 O/G	SD	812115	45670
SMDB250 6W SD ME Optium F3-I/c & FP F1 O/G	SD	812116	49060
SMDB250 8W SD ME Optium F3-I/c & FP F1 O/G	SD	812117	56330
SMDB250 12W SD ME Optium F3-I/c & FP F1 O/G	SD	812118	66770

Optipro SMDB with FP MCCB as Outgoing (Single Door) SMDB 400 - Main Enclosure

HSN Code: 8536

Item Description	Type	Cat Ref.	Unit Price (₹)
SMDB400 4W SD ME Optium F4-I/c & FP F1 O/G	SD	812128	47040
SMDB400 6W SD ME Optium F4-I/c & FP F1 O/G	SD	812129	50640
SMDB400 8W SD ME Optium F4-I/c & FP F1 O/G	SD	812130	58080
SMDB400 12W SD ME Optium F4-I/c & FP F1 O/G	SD	812131	68880
SMDB400 8W SD ME Optium F4-I/c & FP F1-6 & F2-2 O/G	SD	812132	58080
SMDB400 12W SD ME Optium F4-I/c & FP F1-8 & F2-4 O/G	SD	812133	68880
SMDB400 12W SD ME Optium F4-I/c & FP F1-10 & F2-2 O/G	SD	812134	68880

Optipro SMDB with FP MCCB as Outgoing (Single Door) SMDB 630 - Main Enclosure

HSN Code: 8536

Item Description	Type	Cat Ref.	Unit Price (₹)
SMDB630 4W SD ME Optium F4-I/c & FP F1 O/G	SD	812144	70560
SMDB630 6W SD ME Optium F4-I/c & FP F1 O/G	SD	812145	73440
SMDB630 8W SD ME Optium F4-I/c & FP F1 O/G	SD	812146	84240
SMDB630 12W SD ME Optium F4-I/c & FP F1 O/G	SD	812147	99840
SMDB630 8W SD ME Optium F4-I/c & FP F1-6 & F2-2 O/G	SD	812148	84240
SMDB630 12W SD ME Optium F4-I/c & FP F1-8 & F2-4 O/G	SD	812149	99840
SMDB630 12W SD ME Optium F4-I/c & FP F1-10 & F2-2 O/G	SD	812150	99840

Optipro SMDB with TP MCCB as Outgoing (Double Door) SMDB 250 - Main Enclosure

HSN Code: 8536

	Item Description	Type	Cat Ref.	Unit Price (₹)
	SMDB250 4W DD ME Optium F2-I/c & TP F1 O/G	DD	812181	45260
	SMDB250 6W DD ME Optium F2-I/c & TP F1 O/G	DD	812182	48790
	SMDB250 8W DD ME Optium F2-I/c & TP F1 O/G	DD	812183	56090
	SMDB250 12W DD ME Optium F2-I/c & TP F1 O/G	DD	812184	66120
	SMDB250 4W DD ME Optium F3-I/c & TP F1 O/G	DD	812191	47350
	SMDB250 6W DD ME Optium F3-I/c & TP F1 O/G	DD	812192	51000
	SMDB250 8W DD ME Optium F3-I/c & TP F1 O/G	DD	812193	58660
	SMDB250 12W DD ME Optium F3-I/c & TP F1 O/G	DD	812194	69120

Optipro SMDB with TP MCCB as Outgoing (Double Door) SMDB 400 - Main Enclosure

HSN Code: 8536

	Item Description	Type	Cat Ref.	Unit Price (₹)
	SMDB400 4W DD ME Optium F4-I/c & TP F1 O/G	DD	812201	48720
	SMDB400 6W DD ME Optium F4-I/c & TP F1 O/G	DD	812202	52560
	SMDB400 8W DD ME Optium F4-I/c & TP F1 O/G	DD	812203	60480
	SMDB400 12W DD ME Optium F4-I/c & TP F1 O/G	DD	812204	71280
	SMDB400 8W DD ME Optium F4-I/c & TP F1-6 & F2-2 O/G	DD	812205	60480
	SMDB400 12W DD ME Optium F4-I/c & TP F1-8 & F2-4 O/G	DD	812206	71280
	SMDB400 12W DD ME Optium F4-I/c & TP F1-10 & F2-2 O/G	DD	812207	71280

Optipro SMDB with TP MCCB as Outgoing (Double Door) SMDB 630 - Main Enclosure

HSN Code: 8536

	Item Description	Type	Cat Ref.	Unit Price (₹)
	SMDB630 4W DD ME Optium F4-I/c & TP F1 O/G	DD	812217	73200
	SMDB630 6W DD ME Optium F4-I/c & TP F1 O/G	DD	812218	76320
	SMDB630 8W DD ME Optium F4-I/c & TP F1 O/G	DD	812219	87600
	SMDB630 12W DD ME Optium F4-I/c & TP F1 O/G	DD	812220	103440
	SMDB630 8W DD ME Optium F4-I/c & TP F1-6 & F2-2 O/G	DD	812221	87600
	SMDB630 12W DD ME Optium F4-I/c & TP F1-8 & F2-4 O/G	DD	812222	103440
	SMDB630 12W DD ME Optium F4-I/c & TP F1-10 & F2-2 O/G	DD	812223	103440

Optipro SMDB with FP MCCB as Outgoing (Double Door) SMDB 250 - Main Enclosure

HSN Code: 8536

	Item Description	Type	Cat Ref.	Unit Price (₹)
	SMDB250 4W DD ME Optium F2-I/c & FP F1 O/G	DD	812186	49800
	SMDB250 6W DD ME Optium F2-I/c & FP F1 O/G	DD	812187	53660
	SMDB250 8W DD ME Optium F2-I/c & FP F1 O/G	DD	812188	61700
	SMDB250 12W DD ME Optium F2-I/c & FP F1 O/G	DD	812189	72890
	SMDB250 4W DD ME Optium F3-I/c & FP F1 O/G	DD	812196	52130
	SMDB250 6W DD ME Optium F3-I/c & FP F1 O/G	DD	812197	56110
	SMDB250 8W DD ME Optium F3-I/c & FP F1 O/G	DD	812198	64510
	SMDB250 12W DD ME Optium F3-I/c & FP F1 O/G	DD	812199	76180

Optipro SMDB with FP MCCB as Outgoing (Double Door) SMDB 400 - Main Enclosure

HSN Code: 8536

	Item Description	Type	Cat Ref.	Unit Price (₹)
	SMDB400 4W DD ME Optium F4-I/c & FP F1 O/G	DD	812209	53760
	SMDB400 6W DD ME Optium F4-I/c & FP F1 O/G	DD	812210	57840
	SMDB400 8W DD ME Optium F4-I/c & FP F1 O/G	DD	812211	66480
	SMDB400 12W DD ME Optium F4-I/c & FP F1 O/G	DD	812212	78480
	SMDB400 8W DD ME Optium F4-I/c & FP F1-6 & F2-2 O/G	DD	812213	66480
	SMDB400 12W DD ME Optium F4-I/c & FP F1-8 & F2-4 O/G	DD	812214	78480
	SMDB400 12W DD ME Optium F4-I/c & FP F1-10 & F2-2 O/G	DD	812215	78480

Optipro SMDB with FP MCCB as Outgoing (Double Door) SMDB 630 - Main Enclosure

HSN Code: 8536

	Item Description	Type	Cat Ref.	Unit Price (₹)
	SMDB630 4W DD ME Optium F4-I/c & FP F1 O/G	DD	812225	80640
	SMDB630 6W DD ME Optium F4-I/c & FP F1 O/G	DD	812226	83760
	SMDB630 8W DD ME Optium F4-I/c & FP F1 O/G	DD	812227	96480
	SMDB630 12W DD ME Optium F4-I/c & FP F1 O/G	DD	812228	113760
	SMDB630 8W DD ME Optium F4-I/c & FP F1-6 & F2-2 O/G	DD	812229	96480
	SMDB630 12W DD ME Optium F4-I/c & FP F1-8 & F2-4 O/G	DD	812230	113760
	SMDB630 12W DD ME Optium F4-I/c & FP F1-10 & F2-2 O/G	DD	812231	113760

Optipro SMDB - Bottom cable Unit (Single Door)

HSN Code: 8536

	Item Description	Type	Cat Ref.	Unit Price (₹)
	Bottom Cable Unit(for SD SMDB's with F1 O/G only)	SD	812152	4580
	Bottom Cable Unit(for SD SMDB's with F1 & F2 O/G)	SD	812153	5160

Optipro SMDB 250 - Cable Alley Unit (Single Door)

HSN Code: 8536

	Item Description	Type	Cat Ref.	Unit Price (₹)
	SMDB250 Cable Alley-4W SD	SD	812154	10850
	SMDB250 Cable Alley-6W SD	SD	812155	12790
	SMDB250 Cable Alley-8W SD	SD	812156	13820
	SMDB250 Cable Alley-12W SD	SD	812157	15580

Optipro SMDB 400/630 - Cable Alley (Single Door)

HSN Code: 8536

	Item Description	Type	Cat Ref.	Unit Price (₹)
	SMDB400/630 Cable Alley-4W SD	SD	812159	15120
	SMDB400/630 Cable Alley-6W SD	SD	812160	16660
	SMDB400/630 Cable Alley-8W SD	SD	812161	18020
	SMDB400/630 Cable Alley-12W SD	SD	812162	19750
	SMDB400/630 Cable Alley-8W SD	SD	812163	18020
	SMDB400/630 Cable Alley-12W SD	SD	812164	19750
	SMDB400/630 Cable Alley-12W SD	SD	812165	19750
	Metering Unit(for SD SMDB's with F1 O/G only)- with Ammeter,Voltmeter & Phase Indicators(3nos.)	SD	812167	15170
	Metering Unit (for SD SMDB's with F1 & F2 O/G) - with Ammeter,Voltmeter & Phase Indicators(3nos.)	SD	812168	16440
	Metering Unit(for SD SMDB's with F1 O/G only)- with Multifunction meter, Buzzer & Phase Indicators(3nos.)	SD	812169	18960
	Metering Unit (for SD SMDB's with F1 & F2 O/G) - with Multifunction meter, Buzzer & Phase Indicators(3nos.)	SD	812170	20570
	Corner Unit-SD	SD	812171	1820

Optipro SMDB - Bottom cable Unit (Double Door)

HSN Code: 8536

	Item Description	Type	Cat Ref.	Unit Price (₹)
	Bottom Cable Unit(for DD SMDB's with F1 O/G only)	DD	812233	5140
	Bottom Cable Unit(for DD SMDB's with F1 & F2 O/G)	DD	812234	5780

Optipro SMDB 250- Cable Alley Unit (Double Door)

HSN Code: 8536

	Item Description	Type	Cat Ref.	Unit Price (₹)
	SMDB250 Cable Alley-6W DD	DD	812236	14330
	SMDB250 Cable Alley-8W DD	DD	812237	15480
	SMDB250 Cable Alley-12W DD	DD	812238	17450

Optipro SMDB 400/630- Cable Alley Unit (Double Door)

HSN Code: 8536

	Item Description	Type	Cat Ref.	Unit Price (₹)
	SMDB400/630 Cable Alley-4W DD	DD	812240	16940
	SMDB400/630 Cable Alley-6W DD	DD	812241	18670
	SMDB400/630 Cable Alley-8W DD	DD	812242	20180
	SMDB400/630 Cable Alley-12W DD	DD	812243	22130
	SMDB400/630 Cable Alley-8W DD	DD	812244	20180
	SMDB400/630 Cable Alley-12W DD	DD	812245	22130
	SMDB400/630 Cable Alley-12W DD	DD	812246	22130
	Metering Unit(for DD SMDB's with F1 O/G only)- with Ammeter,Voltmeter & Phase Indicators(3nos.)	DD	812248	19730
	Metering Unit (for DD SMDB's with F1 & F2 O/G) - with Ammeter,Voltmeter & Phase Indicators(3nos.)	DD	812249	21360
	Metering Unit(for DD SMDB's with F1 O/G only)- with Multifunction meter, Buzzer & Phase Indicators(3nos.)	DD	812250	24650
	Metering Unit (for DD SMDB's with F1 & F2 O/G) - with Multifunction meter, Buzzer & Phase Indicators(3nos.)	DD	812251	26690
	Corner Unit-DD	DD	812252	1820

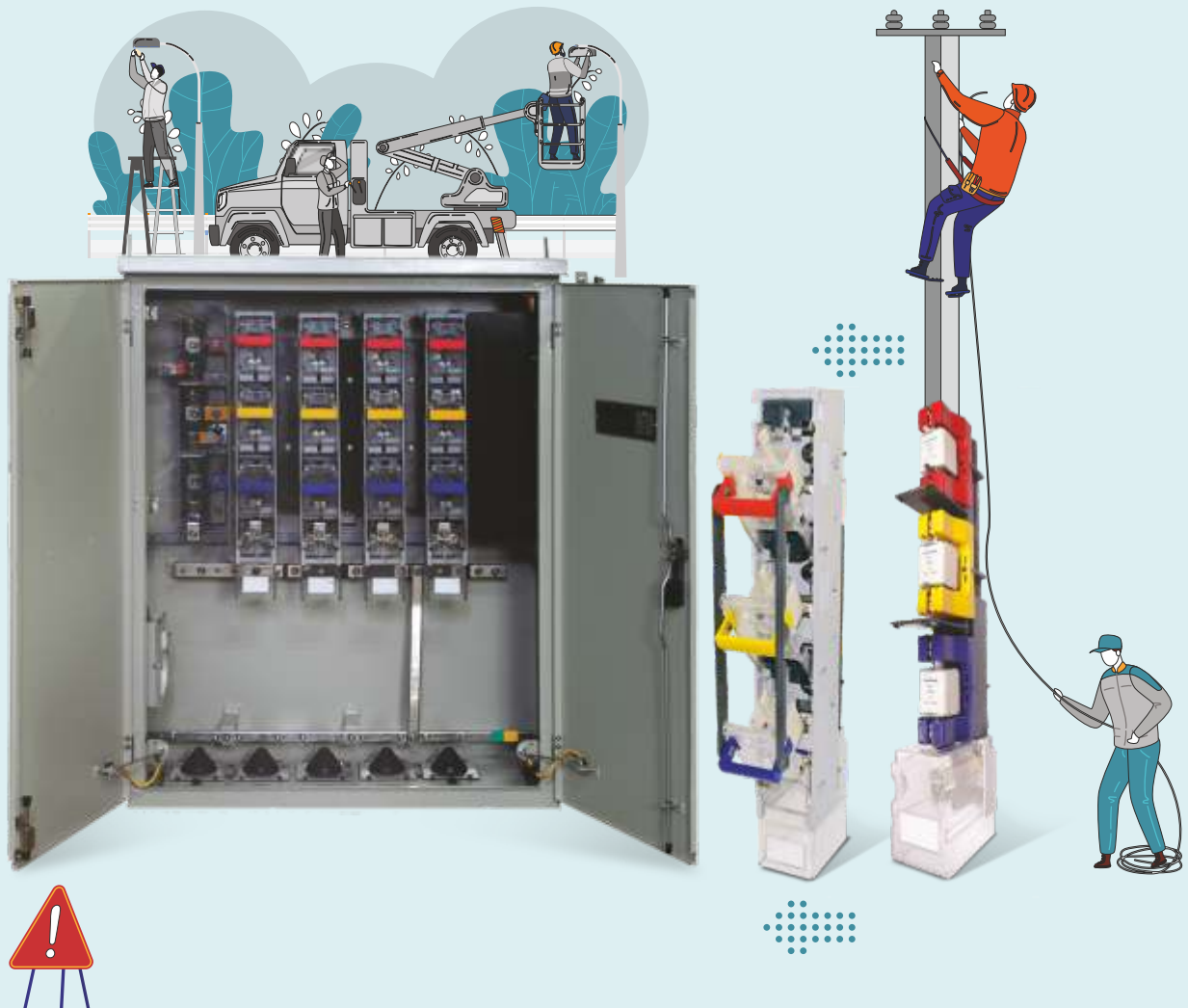

MODULAR DESIGN THAT ENABLES SAFE DISCONNECTION



Complies to
IEC 60947-3



Rated current 250A,
400A and 630A



Modular Construction with
the same dimensions for
all frame sizes

VERTICAL FUSE SWITCHES

HRC FUSE LINKS & BASES

BOLTED TYPE (BS) BREAKING CAPACITY ≥ 80kA 500 V AC 50 Hz.

HSN Code: 8536

Rating	Type	Cat Ref.	Tag Type	Unit Price (₹)	
				Unit Price (₹)	Unit/Carton
2, 4, 6, 8, 10, 16A	FGN	IEFGN***	Offset	88	20
20, 25, 32A	FGN	IEFGN***	Offset	98	20
2, 4, 6, 10, 16, 20, 25, 32A	FSA	IEFSA***	Offset	132	10
35, 40, 50, 63A	FSS	IEFSS***	Offset	148	10
50, 63, 80, 100, 125, 160A	FSDCP	IEDCP***	Offset	314	10
100, 125, 160, 200, 250A	FSFP	IESFP***	Offset	452	3
50, 63, 80, 100, 125A	FSDC	IESDC***	Central	314	10
100, 125, 160, 200, 250A	FSF	IEFSF***	Central	462	3
225, 250, 300, 315, 320A	FSK	IEFSK***	Central	668	3
355, 400A	FMF	IEFMF***	Central	1290	3
355, 400, 450, 500, 560, 600, 630A	FTS	IEFTS***	Central	1488	1
355, 400, 450, 500, 560A	FTM	IEFTM***	2 Central	1920	1
600, 630A	FTM	IEFTM***	2 Central	2640	1

DIN TYPE BREAKING CAPACITY ≥ 80kA 500 V AC 50 Hz.

HSN Code: 8536

Rating Amps	Type	Cat Ref.	Unit Price (₹)	Unit/Carton
2, 4, 6, 10, 16, 20, 25, 32, 50, 63A	Size 000	IWS00***	394	6
2, 4, 6, 10, 16, 20, 25, 32, 36, 40, 50, 63A	Size 00	IW000***	418	6
80, 100A		IW000***	436	6
125, 160A		IW000***	464	6
32, 36, 50, 63, 80, 100, 125, 160, 200A	Size 01	IW001***	766	3
250A		IW001***	872	3
100, 125, 160, 200, 250, 315A	Size 02	IW002***	1124	3
400A		IW002***	1216	3
315, 355, 400, 425A	Size 03	IW003***	1544	3
500, 630A		IW003***	1796	3

* Note HRC fuses with SC breaking capacity 120kA are available on request.

CYLINDRICAL TYPE (IFRH) BREAKING CAPACITY > 80kA 415 V AC.

HSN Code: 8536

Rating	Cat Ref.	Unit Price (₹)
2 to 25A	IFRHO***	166
32 to 40A	IFRHO***	174
50A	IFRH0050	322
63A	IFRH0063	332
Fuse Holder Fr type (2 to 63A)	IFR00***	310

FUSE FITTINGS FOR BOLTED (BS) TYPE

HSN Code: 8536

Rating	Front Connection	Unit Price (₹)	Back Busbar Connection	Unit Price (₹)	Unit/Carton
20A	BFFC 0020	188	BFBC 0020	202	10
32A	BFFC 0032	330	BFBC 0032	342	10
63A	BFFC 0063	474	BFBC 0063	500	5
100A	BFFC 0100	1220	BFBC 0100	1156	3
20A (Stud Type)			BFFCS 020	272	1

FUSE BASES FOR DIN TYPE HRC FUSE LINKS

HSN Code: 8536

Rating Amps	Suitable for	Cat Ref.	Unit Price (₹)	Unit/Carton
6-160A	Size - 00	IWFB0***	538	6
32-250A	Size - 1	IWFB1***	1026	2
100-400A	Size - 2	IWFB2***	1532	2
315-630A	Size - 3	IWFB3***	1944	2

SWITCH DISCONNECTOR FUSES

HSN Code: 8536

Rated Current	Type	IN OPEN EXECUTION*		IN SHEET STEEL ENCLOSURE		Recommended HRC Fuse Indo Asian Make
		Cat Ref.	Unit Price (₹)	Cat Ref.	Unit Price (₹)	
32A BS	TPN	INO1A032	1952	INS1A032	3982	FSA
63A BS	TPN	INO1A063	2700	INS1A063	5074	FSS
100A BS	TPN	INO1A100	5936	INS1A100	8304	FSDCP
125A BS	TPN	INO1A125	6660	INS1A125	9952	FSDCP
160A BS	TPN	INO1A160	8062	INS1A160	11112	FSDCP
200A BS	TPN	INO1A200	10030	INS1A200	12926	FSF
250A BS	TPN	INO1A250	11324	INS1A250	14944	FSF
315A BS	TPN	INO1A315	14510	INS1A315	18660	FSK
400A BS	TPN	INO1A400	18010	INS1A400	22274	FMF
32A BS	TPSN	INO1B032	2480	INS1B032	4200	FSA
63A BS	TPSN	INO1B063	3150	INS1B063	4970	FSS
100A BS	TPSN	INO1B100	7298	INS1B100	9298	FSDCP
125A BS	TPSN	INO1B125	7992	INS1B125	9952	FSDCP
160A BS	TPSN	INO1B160	9996	INS1B160	12862	FSDCP
200A BS	TPSN	INO1B200	11386	INS1B200	14230	FSF
250A BS	TPSN	INO1B250	12414	INS1B250	15978	FSF
315A BS	TPSN	INO1B315	17566	INS1B315	22320	FSK
400A BS	TPSN	INO1B400	20780	INS1B400	23216	FMF

* Price Does Not Include HRC Fuse

HSN Code: 8536

Rated Current	Type	IN OPEN EXECUTION*		IN SHEET STEEL ENCLOSURE		Recommended HRC Fuse Indo Asian Make
		Cat Ref.	Unit Price (₹)	Cat Ref.	Unit Price (₹)	
32A DIN	TPN	IN10A032	2050	IN1SA032	3790	Size 000
63A DIN	TPN	IN10A063	2844	IN1SA063	4818	Size 000
100A DIN	TPN	IN10A100	6084	IN1SA100	8212	Size 00
125A DIN	TPN	IN10A125	6952	IN1SA125	9924	Size 00
160A DIN	TPN	IN10A160	8366	IN1SA160	10902	Size 00
200A DIN	TPN	IN10A200	10444	IN1SA200	12408	Size 01
250A DIN	TPN	IN10A250	11700	IN1SA250	14936	Size 01
315A DIN	TPN	IN10A315	15030	IN1SA315	18592	Size 02
400A DIN	TPN	IN10A400	18528	IN1SA400	22038	Size 02
630A DIN	TPN	IN10A630	29184	IN1SA630	31430	Size 03
800A DIN	TPN	IN10A800	35584	IN1SA800	44492	Size 03
32A DIN	TPSN	IN10B032	2906	IN1SB032	3900	Size 000
63A DIN	TPSN	IN10B063	3350	IN1SB063	4212	Size 000
100A DIN	TPSN	IN10B100	7506	IN1SB100	8400	Size 00
125A DIN	TPSN	IN10B125	8318	IN1SB125	9042	Size 00
160A DIN	TPSN	IN10B160	9746	IN1SB160	12090	Size 00
200A DIN	TPSN	IN10B200	11326	IN1SB200	12752	Size 01
250A DIN	TPSN	IN10B250	12972	IN1SB250	14610	Size 01
315A DIN	TPSN	IN10B315	17362	IN1SB315	19880	Size 02
400A DIN	TPSN	IN10B400	20176	IN1SB400	24824	Size 02
630A DIN	TPSN	IN10B630	32392	IN1SB630	33954	Size 03
800A DIN	TPSN	IN10B800	37454	IN1SB800	48940	Size 03

* Price Does Not Include HRC Fuse

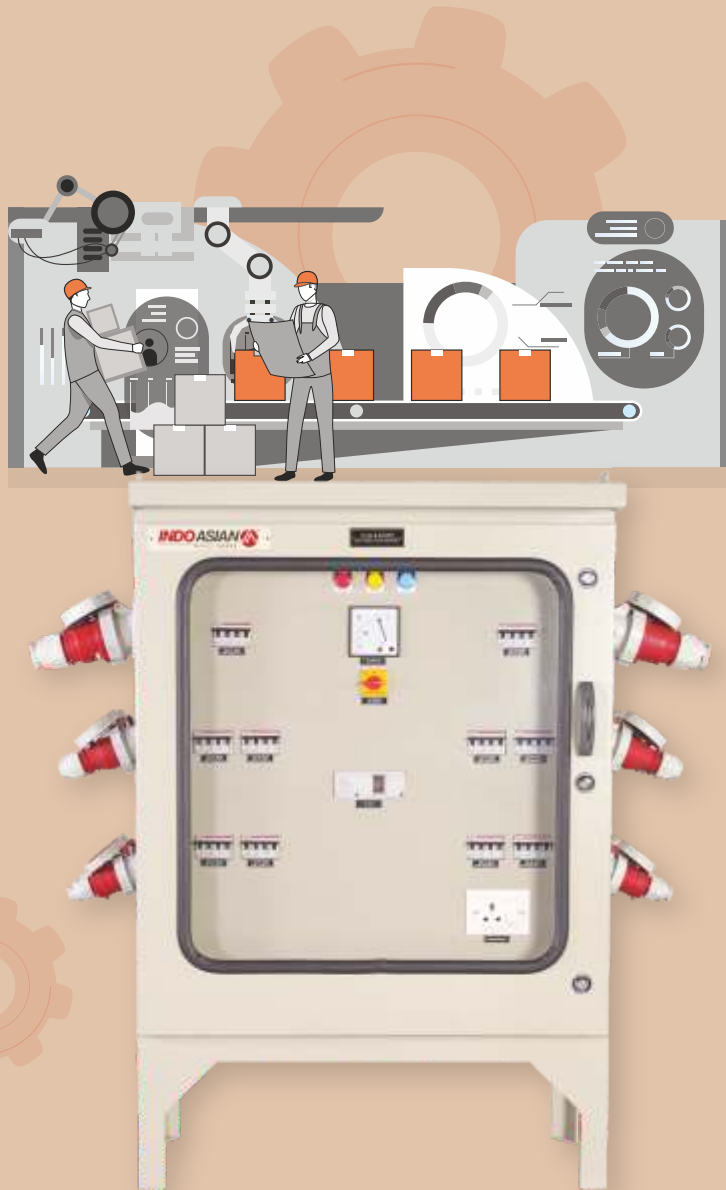

PROVIDING YOU SAFE AND RELIABLE POWER CONNECTION SOURCE DURING ANY CONSTRUCTION



Degree of protection IP55



Metering and Indication Lamps



Suitable for Single Phase & Three Phase Connection



Pre-Fitted Plug & Sockets with three/five Pin Sockets

PORTABLE POWER CONNECTION BOARD (PPCB)

SWITCH DISCONNECTOR 4 POLE

HSN Code: 8536

Rated Current	IN OPEN EXECUTION*		IN SHEET STEEL ENCLOSURE	
	Cat Ref.	Unit Price (₹)	Cat Ref.	Unit Price (₹)
32A	IN1SD032	2048	IN1ED032	3912
63A	IN1SD063	3168	IN1ED063	4622
100A	IN1SD100	4912	IN1ED100	8398
125A	IN1SD125	6402	IN1ED125	9530
160A	IN1SD160	8022	IN1ED160	11168
200A	IN1SD200	8934	IN2ED200	13816
250A	IN1SD250	11576	IN2ED250	18226
315A	IN1SD315	12582	IN3ED315	19922
400A	IN1SD400	14766	IN3ED400	23356
630A	IN1SD630	20492	IN4ED630	34074
800A	IN1SD800	24406	IN4ED800	39468

*Prices of 3 Pole SD is available on Request.

**Ambidex CHANGEOVER SWITCHES
ON-LOAD CHANGEOVER SWITCHES 4 POLE**

HSN Code: 8536

Rated Current	IN OPEN EXECUTION		IN SHEET STEEL ENCLOSURE	
	Cat Ref.	Unit Price (₹)	Cat Ref.	Unit Price (₹)
63A	ITAE0063	5622	ITAS0063	8808
100A	ITAE0100	7462	ITAS0100	11190
125A	ICAE0125	11180	ICAS0125	16764
160A	ICAE0160	12296	ICAS0160	18438
200A	ICAE0200	14784	ICAS0200	21472
250A	ICAE0250	21166	ICAS0250	28548
320A	ICAE0320	22414	ICAS0320	30774
400A	ICAE0400	32526	ICAS0400	51096
630A	ICAE0630	38318	ICAS0630	54754
800A	ITAE0800	53438	ITAS0800	80214
1000A	ITAE1000	96670	ITAS1000	134436
1250A	ITAE1250	129738	ITAS1250	185598
1600A	ITAE1600	148972	ITAS1600	246264
2000A	ITAE2000	217848	ITAS2000	301958
2500A	ITAE2500	299712	ITAS2500	400528
3150A	ITAE3150	306537	ITAS3150	519950

HSN Code: 8536

ACCESSORIES FOR AMBIDEX CHANGEOVER SWITCHES	Cat Ref.	Unit Price (₹)
Auxiliary Switch 200A-630A (1NO + 1NC)	ICA00AUX	224
Spreader Links for Frame00 - 1 set (4 links)	ICA00SPL	350

ON-LOAD SWITCH FUSE CHANGEOVER

HSN Code: 8536

Rated Current	IN OPEN EXECUTION		IN SHEET STEEL ENCLOSURE		Recommended HRC Fuse Indo Asian Make
	Cat Ref.	Unit Price (₹)	Cat Ref.	Unit Price (₹)	
125A	ITBE0125	15242	ITBS0125	23294	FSDCP
200A	ITBE0200	27848	ITBS0200	41346	FSF
250A	ITBE0250	28110	ITBS0250	41730	FSK
320A	ITBE0320	29022	ITBS0320	43088	FSK
400A	ITBE0400	41628	ITBS0400	61802	FTS
630A	ITBE0630	48582	ITBS0630	72132	FTS

Price does not include HRC Fuses.

ON-LOAD BY-PASS SWITCHES

HSN Code: 8536

Rated Current	IN OPEN EXECUTION		IN SHEET STEEL ENCLOSURE	
	Cat Ref.	Unit Price (₹)	Cat Ref.	Unit Price (₹)
125A	ITCE0125	21370	ITCS0125	28854
200A	ITCE0200	27212	ITCS0200	36736
250A	ITCE0250	39530	ITCS0250	53366
320A	ITCE0320	41046	ITCS0320	55414
400A	ITCE0400	61568	ITCS0400	83120
630A	ITCE0630	69948	ITCS0630	94434

REWIRABLE SWITCH FUSE UNIT

HSN Code: 8537

 <ul style="list-style-type: none"> • Single Pole & Neutral/Double Pole 240/415 VAC 50 Hz • Conforms to IS/IEC 13947-3 	Rating	Type	Cat Ref.	Rated Voltage	Unit Price* (₹)
	16A	SPN	RCSPN016	240 V	816
	32A	SPN	RCSPN032	240 V	1964
	16A	DP	RCDP0016	240 V	860
	32A	DP	RCDP0032	240 V	2018
	32A	DP	#DDP0032	415 V	2774
	63A	DP	#DDP0063	415 V	5202

For Rewirable type carrier, prefix R, for HRC type carrier, prefix H.
* These prices are without wire & HRC.

COMBINATION FUSE SWITCH

HSN Code: 8536

 <ul style="list-style-type: none"> • Double Break in Sheet steel enclosure • Conforms to IS/IEC 13947-3 • Rated Voltage - 415V AC 50 Hz • Type - TPN 	Rating	HRC Fuse Type	Cat Ref.	Unit Price* (₹)
	63A	FSS	DDTPN063	9854
	100A	FSDCP	DDTPN100	13232
	200A	FSF	DDTPN200	19696
	300A	FSK	DDTPN300	24848
	400A	FTS	DDTPN400	36044

* These prices are without HRC.

**TRIPLE POLE NEUTRAL HRC TYPE
REWIRABLE SWITCH FUSE UNIT**

HSN Code: 8537 H
HSN Code: 8536 R

 <ul style="list-style-type: none"> • Rated Voltage - 415V-AC 50Hz • Type - TPN 	Rating	HRC Fuse Type	Cat Ref.	Unit Price* (₹)
	16A	FSA	#DTPN016	2378
	32A	FSA	#DTPN032	3200
	63A	FSS	#DTPN063	6810
	100A	FSDCP	#DTPN100	12422

For Rewirable type carrier, prefix R, for HRC type carrier, prefix H.
* These prices are without wire & HRC.

OFF LOAD CHANGEOVER SWITCH

HSN Code: 8536

 <ul style="list-style-type: none"> • With enclosure • Rated Voltage - 415V-AC 50Hz • Type - FP 	Rating	Cat Ref.	Unit Price (₹)
	32A (DP)	OFDP0032	1936
	16A	OFFP0016	3100
	32A	OFFP0032	3236
	63A	OFFP0063	6576
	100A	OFFP0100	12854
	125A	OFFP0125	18070
	200A	OFFP0200	19508
	250A	OFFP0250	24852
	315A	OFFP0315	25656
	400A	OFFP0400	29930

Prices for spares of Rewirable Switch Fuse Unit like Action Bar, Base Plate, End Shield, Bakelite Contact Shrouds are available on request.



*Available in single plate and double plate

GIVE YOUR WALLS AN EXPERIENCE OF GLINT



Honeycomb Effect



Comes with both wooden & metal screws



USB charger with 1 & 2 Module



Range from 1M to 18M

ISI marked 6A socket

Glint™
Welcome Change

Glint™ SWITCH / SWITCH WITH INDICATOR

• Polycarbonate Material • LED Indicator • ISI Marked

HSN Code: 8536

	Description	Module	Pack	Cat. Nos.	Unit Price (₹)
	6A 1-way Switch	1	1/20/400	800000	32
6A 2-way Switch	1	1/20/200	800001	66	
16A 1-way Switch	1	1/20/200	800002	90	
16A 2-way Switch	1	1/10/100	800003	114	
16A 1-way Switch with indicator	1	1/10/100	800004	110	
20A DP Switch	2	1/10/50	800005	134	
32A DP Switch	2	1/10/50	800006	200	
6A Bell Push with indicator-1M	1	1/10/100	800007	78	
6A Bell Push with indicator-2M	2	1/10/100	800008	116	

Glint™ SOCKET / TELEPHONE SOCKET / COMPUTER SOCKET / TV SOCKET

HSN Code: 8536

• Pencil Free Operation • Child Safety Shutter • Accommodate Wide Range of 2 Pin Round and Flat Pin Plugs • *ISI mark

	Description	Module	Pack	Cat. Nos.	Unit Price (₹)
	6A 3 Pin Universal Socket	2	1/20/200	800020	66
10A Euro US Socket	1	1/20/100	800021	58	
6/16A 3 Pin Socket*	2	1/10/100	800022	124	
6A 3 Pin Socket*	2	1/10/100	801800	82	
Multistandard Socket 6/10/13A-250V, 15A-127V	2	1/10/100	800023	118	
Telephone Socket - RJ11	1	1/20/100	800030	70	
Computer Socket- RJ45	1	1/20/100	800031	162	
TV Socket	1	1/20/100	800032	64	

Glint™ USB CHARGER

Modular charging socket to charge your Mobile , Tested as per IS standard

HSN Code: 8536

	Description	Module	Pack	Cat. Nos.	Unit Price (₹)
	USB Charger	2	5/50	800019	954
USB Charger 1.5A	1	10/100	800044	714	

Glint™ BUZZER / POWER UNIT / INDICATOR

HSN Code: 8536

• Power Unit - Prewired, Suitable for 2 Ton Ac / 3.5 kw Geyser

	Description	Module	Pack	Cat. Nos.	Unit Price (₹)
	Buzzer - 230V	1	1/20/100	800040	174
16A Power Unit for AC & Geyser	4	1/1/5	800025	308	
Flat Indicator Red	1	1/10/100	800033	88	

Glint™ FAN STEP REGULATOR

HSN Code: 8414

• Fan Marking for Easy Identification

	Description	Module	Pack	Cat. Nos.	Unit Price (₹)
	Fan Step Regulator - 100W	1	1/10/100	800041	304
Fan Step Regulator - 100W - 2M	2	1/10/100	800043	342	

Glint™ LIGHT DIMMER

HSN Code: 8538

• Marking for Easy Identification

	Description	Module	Pack	Cat. Nos.	Unit Price (₹)
	Light Dimmer - 400W	1	1/10/100	800042	296

Glint™ MINI MCB

HSN Code: 8536

- Marking for Easy Identification

	Description	Module	Pack	Cat. Nos.	Unit Price (₹)
	MINI MCB SP 16A	1	1/10/100	800010	288
	MINI MCB SP 20A	1	1/10/100	800011	288
	MINI MCB SP 25A	1	1/10/100	800012	288
	MINI MCB SP 32A	1	1/10/100	800013	288

Glint™ BLANK PLATE / SCREW CAPS

HSN Code: 8538

- Spare Screw Caps Available

	Description	Module	Pack	Cat. Nos.	Unit Price (₹)
	1 Module Blank Plate	1	1/20/200	800051	20
	2 Module Blank Plate	2	1/10/100	800052	24
	Screw Caps	-	1/10/100	800059	20*

* One Unit Contains Ten Pieces of Screw Caps

Glint™ MODULAR PLATES - WHITE COLOUR

- Unique Design - Sleek & Curvy • Flame Retardant Material • Compatible with Standard Size of Metal Flush & Plastic Surface Boxes

HSN Code: 8538

	Description	Module	Pack	Cat. Nos.	Unit Price (₹)
	1 Module Plate	1	1/10/100	800061	46
	2 Module Plate	2	1/10/100	800062	46
	3 Module Plate	3	1/10/100	800063	66
	4 Module Plate	4	1/10/100	800064	78
	6 Module Plate	6	1/5/50	800066	96
	8 Module Plate (Vertical)	8	1/5/25	800067	136
	8 Module Plate (Horizontal)	8	1/5/50	800068	128
	12 Module Plate	12	1/5/25	800065	174
	16 Module Plate	16	1/5/25	800069	182
	18 Module Plate	18	1/5/25	800070	220

Glint™ MODULAR DOUBLE PLATES - WHITE COLOUR

- Aesthetic Design • Suitable for Metal Flush & Wooden Boxes
- Comes with both Metal & Wooden Screws

HSN Code: 8538

	Description	Module	Pack	Cat. Nos.	Unit Price (₹)
	Double Plate + Frame 1M	1	1/10/100	800071	70
	Double Plate + Frame 2M	2	1/10/100	800072	70
	Double Plate + Frame 3M	3	1/10/100	800073	90
	Double Plate + Frame 4M	4	1/10/100	800074	110
	Double Plate + Frame 6M	6	1/10/50	800076	140
	Double Plate + Frame 8M (Vertical)	8	1/5/25	800078	198
	Double Plate + Frame 8M (Horizontal)	8	1/10/50	800079	198
	Double Plate + Frame 10M	10	1/5/25	800080	232
	Double Plate + Frame 12M (Vertical)	12	1/5/25	800082	252
	Double Plate + Frame 12M (Horizontal)	12	1/5/25	800084	252
	Double Plate + Frame 16M	16	1/5/25	800086	288
	Double Plate + Frame 18M	18	1/5/25	800088	314

Glint™ METAL FLUSH BOX

• Made of G.I. Sheet • Earth Terminal for Safety

HSN Code: 8538

	Description	Module	Pack	Cat. Nos.	Unit Price (₹)
	Metal Flush Box - 1 / 2 Module	1 / 2	1/0/40	800172	62
	Metal Flush Box - 3 Module	3	1/0/40	800173	82
	Metal Flush Box - 4 Module	4	1/0/40	800174	96
	Metal Flush Box - 6 Module	6	1/0/20	800176	144
	Metal Flush Box - 8 Module(V)	8	1/0/20	800177	188
	Metal Flush Box - 8 Module(H)	8	1/0/20	800178	188
	Metal Flush Box - 12 Module	12	1/0/10	800175	248
	Metal Flush Box - 16 Module	16	1/0/10	800179	284
	Metal Flush Box - 18 Module	18	1/0/10	800180	310

Glint™ SURFACE BOX

• Flame Retardant Material • Edge to Edge Fitting with Glint Plate

HSN Code: 8538

	Description	Module	Pack	Cat. Nos.	Unit Price (₹)
	Plastic Surface Box 1/2 Module	1 / 2	1/0/50	800182	66
	Plastic Surface Box - 3 Module	3	1/0/35	800183	84
	Plastic Surface Box - 4 Module	4	1/0/25	800184	96
	Plastic Surface Box - 6 Module	6	1/0/10	800186	148
	Plastic Surface Box - 8 Module (V)	8	1/0/15	800187	200
	Plastic Surface Box - 8 Module (H)	8	1/0/10	800188	200
	Plastic Surface Box - 12 Module	12	1/0/10	800185	252
	Plastic Surface Box - 16 Module	16	1/0/10	800189	294
	Plastic Surface Box - 18 Module	18	1/0/10	800190	320

Cover Plates - Glint™

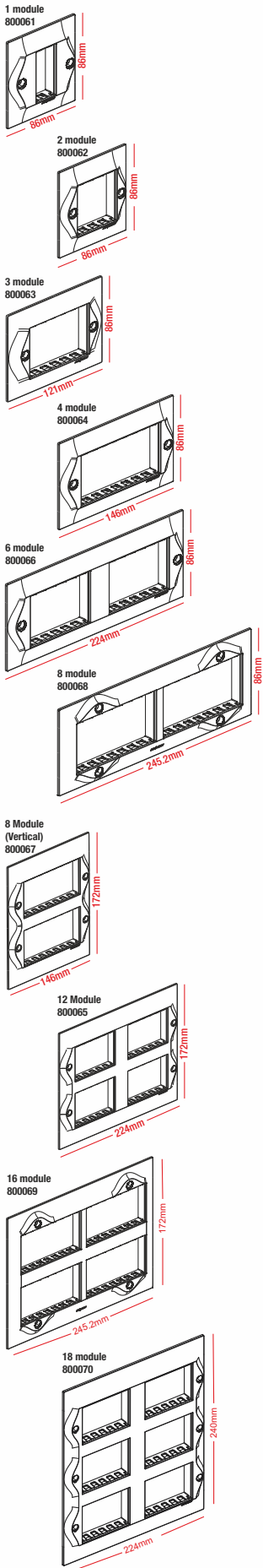

Flush Boxes-Metal

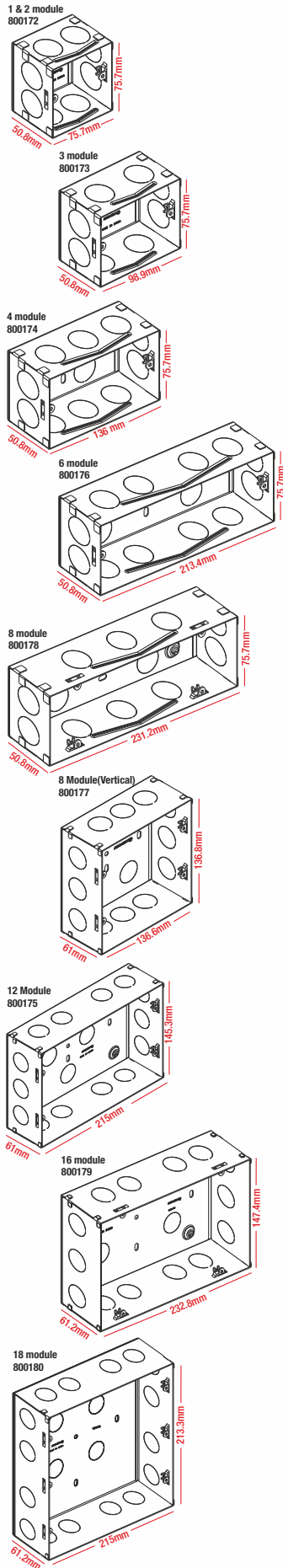

Surface Boxes

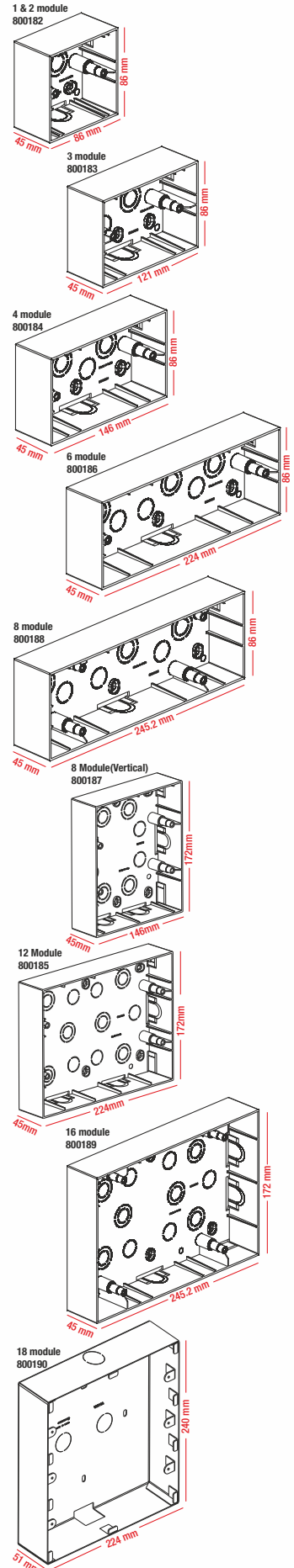



* tested in a controlled environment

#TurnOnYourStyleSense

COLOURS THAT REFLECT YOUR PERSONALITY



All four colour



Trending colours



Contemporary finishes



More resistant to scratches & Fading*

ELVIRA
A SENSIBLE SWITCH

ISI marked 6A socket

ELVIRA SWITCH / SWITCH WITH INDICATOR
A SENSIBLE SWITCH

• Polycarbonate Material • LED Based Indicator • Shrouded Terminal • ISI Marked

HSN Code: 8536

	Description	Module	Pack	Cat. Nos.	Unit Price (₹)
	6A 1 way Switch	1	1/20/400	800100	36
6A 2 way Switch	1	1/20/100	800101	84	
6A 1 way Switch with indicator	1	1/20/200	800102	82	
16A 1 way Switch	1	1/20/200	800103	102	
16A 2 way Switch	1	1/10/100	800104	140	
16A 1way Switch with indicator	1	1/20/200	800105	124	
25A 1 way Switch with indicator	1	1/10/100	800106	182	
20A DP Switch	2	1/10/50	800107	176	
32A DP Switch	2	1/10/50	800108	244	
6A Bell Push with indicator - 1M	1	1/20/200	800110	90	
6A Bell Push with indicator - 2M	2	1/10/100	800111	140	

ELVIRA SOCKET
A SENSIBLE SWITCH

• Child Safety Shutter • Shrouded Terminals • Compatible with all standard Mobile chargers • *ISI mark

HSN Code: 8536

	Description	Module	Pack	Cat. Nos.	Unit Price (₹)
	6A 3 Pin Universal Socket	2	1/20/200	800120	92
10A Euro US Socket	1	1/20/100	800121	78	
6/16A 3 Pin Socket*	2	1/10/50	800122	166	
6A 3 Pin Socket*	2	1/10/50	802800	88	
25A 3 Pin Socket	2	1/10/50	800124	192	
Multistandard Socket 6/10/13A-250v	2	1/10/100	800123	160	

ELVIRA USB CHARGER
A SENSIBLE SWITCH

Modular charging socket to charge your Mobile , Tested as per IS standard

HSN Code: 8536

	Description	Module	Pack	Cat. Nos.	Unit Price (₹)
	USB Charger	1	10/100	800112	652
USB Charger 1.5A	1	10/100	800145	794	
USB Charger	2	5/50	800113	1180	

ELVIRA RJ11 / RJ45 / TV SOCKET
A SENSIBLE SWITCH

Tool less, Twisted operation Computer Socket/RJ45

HSN Code: 8536

	Description	Module	Pack	Cat. Nos.	Unit Price (₹)
	Telephone Socket - RJ11	1	1/20/100	800130	90
Computer Socket - RJ45 Cat 6	1	1/20/100	800131	234	
TV Socket	1	1/20/100	800132	88	

ELVIRA FAN REGULATOR
A SENSIBLE SWITCH

• Laser marking • ISI mark

HSN Code: 8414

	Description	Module	Pack	Cat. Nos.	Unit Price (₹)
	Fan Step Regulator 100W -1M	1	1/10/100	800141	336
Fan Step Regulator 100W -2M	2	1/10/100	800142	406	

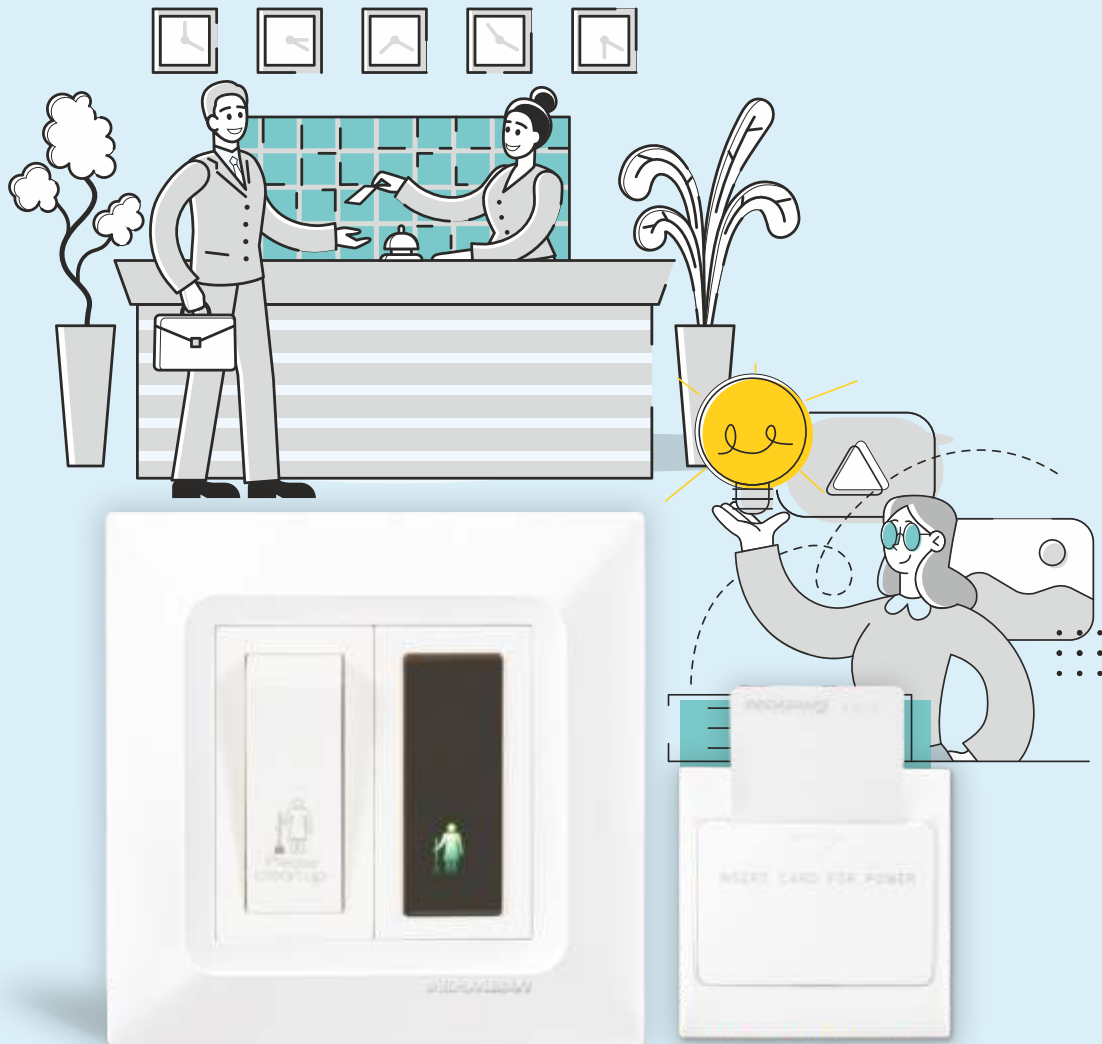

HOSPITALITY SOLUTIONS FOR UTMOST CONVENIENCE

DND & MMR :

- Make My Room and Do Not Disturb Indicator
- Quality Assurance as per company standards

Key Card :

- Monoblock electronic switch
- Activat switch by card insertion

ELVIRA
A SENSIBLE SWITCH

ELVIRA POWER UNIT / CONTROL PRODUCTS / MINI MCB
A SENSIBLE SWITCH

• LED Indicator • Pre-Wired Power Unit

HSN Code: 8536

Description	Module	Pack	Cat. Nos.	Unit Price (₹)	
				Module	Pack
Buzzer 230V	1	1/20/100	800140		246
Power Unit with 16A AC & GYSR	3	1/1/5	800125		348
Power Unit with 20A MCB & PLUG	3	1/1/5	800193		850
Power Unit with 25A MCB & PLUG	3	1/1/5	800194		914
Bell Call Indicator	1	1/20/100	800144		530
Flat Indicator Red	1	1/20/100	800154		104
Skirting light - 2M	2	1/5/25	800155		380
25A Motor Starter	2	1/5/25	800196		404
16A Mini MCB SP C curve	1	1/10/100	800160		360
20A Mini MCB SP C curve	1	1/10/100	800191		360
25A Mini MCB SP C curve	1	1/10/100	800156		360
32A Mini MCB SP C curve	1	1/10/100	800157		360

ELVIRA LIGHT DIMMER
A SENSIBLE SWITCH

• Laser marking

HSN Code: 8538

Description	Module	Pack	Cat. Nos.	Unit Price (₹)	
				Module	Pack
Light Dimmer 400W	1	1/10/100	800143		346

ELVIRA HOTEL FUNCTION (KEY CARD AND DND)
A SENSIBLE SWITCH

• LED Indicator

HSN Code: 8538

Description	Module	Pack	Cat. Nos.	Unit Price (₹)	
				Module	Pack
DND Internal Unit	1	1/10/100	800192		174
DND External Unit	1	1/10/100	800195		208
Key Card SW 16A	2	1/10	800197		2028

ELVIRA BLANK PLATES / CABLE OUTLET
A SENSIBLE SWITCH

• Polycarbonate Material

HSN Code: 8538

Description	Module	Pack	Cat. Nos.	Unit Price (₹)	
				Module	Pack
1 module Blank	1	1/20/200	800151		29
2 module Blank	2	1/10/100	800152		40
Cable outlet	1	1/20/100	800153		72

ELVIRA MODULAR PLATE WITH SUPPORT FRAME - WHITE
A SENSIBLE SWITCH

• Strong Dimensional Stability

HSN Code: 8538

Description	Module	Pack	Cat. Nos.	Unit Price (₹)	
				Module	Pack
1 Module Plate	1	1/10/100	800161		70
2 Module Plate	2	1/10/100	800162		70
3 Module Plate	3	1/10/100	800163		92
4 Module Plate	4	1/10/100	800164		102
6 Module Plate	6	1/5/50	800166		136
8 Module Plate (Horizontal)	8	1/5/50	800168		182
8 Module Plate (Vertical)	8	1/5/25	800167		186
12 Module Plate	12	1/5/25	800165		262
16 Module Plate	16	1/5/25	800169		304
18 Module Plate	18	1/5/25	800170		360

ELVIRA MODULAR PLATE WITH SUPPORT FRAME - SILVER LIGHT PURPLE

A SENSIBLE SWITCH

• Strong Dimensional Stability



HSN Code: 8538

 	Description	Module	Pack	Cat. Nos.	Unit Price (₹)
	Silver Light purple Plate 1M	1	1/10/100	800201	128
	Silver Light purple Plate 2M	2	1/10/100	800202	128
	Silver Light purple Plate 3M	3	1/10/100	800203	160
	Silver Light purple Plate 4M	4	1/10/100	800204	180
	Silver Light purple Plate 6M	6	1/5/50	800205	264
	Silver Light purple Plate 8M (Horizontal)	8	1/5/50	800206	282
	Silver Light purple Plate 8M (Vertical)	8	1/5/25	800207	342
	Silver Light purple Plate 12M	12	1/5/25	800208	488
	Silver Light purple Plate 16M	16	1/5/25	800209	664
Silver Light purple Plate 18M	18	1/5/25	800210	690	

ELVIRA MODULAR PLATE WITH SUPPORT FRAME - INOX SILVER

A SENSIBLE SWITCH



HSN Code: 8538

 	Description	Module	Pack	Cat. Nos.	Unit Price (₹)
	Inox Silver Plate 1M	1	1/10/100	800211	128
	Inox Silver Plate 2M	2	1/10/100	800212	128
	Inox Silver Plate 3M	3	1/10/100	800213	160
	Inox Silver Plate 4M	4	1/10/100	800214	180
	Inox Silver Plate 6M	6	1/5/50	800215	264
	Inox Silver Plate 8M (Horizontal)	8	1/5/50	800216	282
	Inox Silver Plate 8M (Vertical)	8	1/5/25	800217	342
	Inox Silver Plate 12M	12	1/5/25	800218	488
	Inox Silver Plate 16M	16	1/5/25	800219	664
Inox Silver Plate 18M	18	1/5/25	800220	690	

ELVIRA MODULAR PLATE WITH SUPPORT FRAME - POLARISED GREY

A SENSIBLE SWITCH



HSN Code: 8538

 	Description	Module	Pack	Cat. Nos.	Unit Price (₹)
	Polarised Grey Plate 1M	1	1/10/100	800221	128
	Polarised Grey Plate 2M	2	1/10/100	800222	128
	Polarised Grey Plate 3M	3	1/10/100	800223	160
	Polarised Grey Plate 4M	4	1/10/100	800224	180
	Polarised Grey Plate 6M	6	1/5/50	800225	264
	Polarised Grey Plate 8M (Horizontal)	8	1/5/50	800226	282
	Polarised Grey Plate 8M (Vertical)	8	1/5/25	800227	342
	Polarised Grey Plate 12M	12	1/5/25	800228	488
	Polarised Grey Plate 16M	16	1/5/25	800229	664
Polarised Grey Plate 18M	18	1/5/25	800230	690	

ELVIRA MODULAR PLATE WITH SUPPORT FRAME - ASH PURPLE

A SENSIBLE SWITCH

HSN Code: 8538

 	Description	Module	Pack	Cat. Nos.	Unit Price (₹)
	Ash Purple Plate 1M	1	1/10/100	800231	128
	Ash Purple Plate 2M	2	1/10/100	800232	128
	Ash Purple Plate 3M	3	1/10/100	800233	160
	Ash Purple Plate 4M	4	1/10/100	800234	180
	Ash Purple Plate 6M	6	1/5/50	800235	264
	Ash Purple Plate 8M (Horizontal)	8	1/5/50	800236	282
	Ash Purple Plate 8M (Vertical)	8	1/5/25	800237	342
	Ash Purple Plate 12M	12	1/5/25	800238	488
	Ash Purple Plate 16M	16	1/5/25	800239	664
Ash Purple Plate 18M	18	1/5/25	800240	690	

ELVIRA METAL FLUSH BOX
A SENSIBLE SWITCH

• Made of G.I. Sheet • Earth Terminal for Safety

HSN Code: 8538

	Description	Module	Pack	Cat. Nos.	Unit Price (₹)
	Metal Flush Box - 1 / 2 Module	1 / 2	1/0/40	800172	62
	Metal Flush Box - 3 Module	3	1/0/40	800173	82
	Metal Flush Box - 4 Module	4	1/0/40	800174	96
	Metal Flush Box - 6 Module	6	1/0/20	800176	144
	Metal Flush Box - 8 Module(V)	8	1/0/20	800177	188
	Metal Flush Box - 8 Module(H)	8	1/0/20	800178	188
	Metal Flush Box - 12 Module	12	1/0/10	800175	248
	Metal Flush Box - 16 Module	16	1/0/10	800179	284
	Metal Flush Box - 18 Module	18	1/0/10	800180	310

ELVIRA SURFACE BOX
A SENSIBLE SWITCH

• Flame Retardant Material • Edge to Edge Fitting with Plate

HSN Code: 8538

	Description	Module	Pack	Cat. Nos.	Unit Price (₹)
	Plastic Surface Box 1/2 Module	1 / 2	1/0/50	800182	66
	Plastic Surface Box - 3 Module	3	1/0/35	800183	84
	Plastic Surface Box - 4 Module	4	1/0/25	800184	96
	Plastic Surface Box - 6 Module	6	1/0/10	800186	148
	Plastic Surface Box - 8 Module (V)	8	1/0/15	800187	200
	Plastic Surface Box - 8 Module (H)	8	1/0/10	800188	200
	Plastic Surface Box - 12 Module	12	1/0/10	800185	252
	Plastic Surface Box - 16 Module	16	1/0/10	800189	294
	Plastic Surface Box - 18 Module	18	1/0/10	800190	320

3 PIN PLUGS WITH EASY GRIP

• White Matt Finish • Tested as per IS 1293

HSN Code: 8536

	Description	Pack	Cat. Nos.	Unit Price (₹)
	6A 3 Pin Plug	1/10/50	698470	78
	16A 3 Pin Plug	1/10/50	698471	114

EXHAUST FAN

• Copper Motor • RoHS Compliant • Rust Free Body

HSN Code: 8536

	Description	Pack	Cat. Nos.	Unit Price (₹)
	Exhaust Fan 150mm White	1/0/6	698500	1750
	Exhaust Fan 200mm White	1/0/6	698501	1950
	Exhaust Fan 250mm White	1/0/6	698501	2250



ENCOURAGE HAPPY EXPERIMENT



RoHS
Compliant



Low Power
Consumption



Copper Motor

PRODUCT	150 mm	200 mm	250 mm
MRP (Per Unit)	1,750	1,950	2,250

Zosta™
The powerful Exhaust fan

Cover Plates - ELVIRA
A SENSIBLE SWITCH

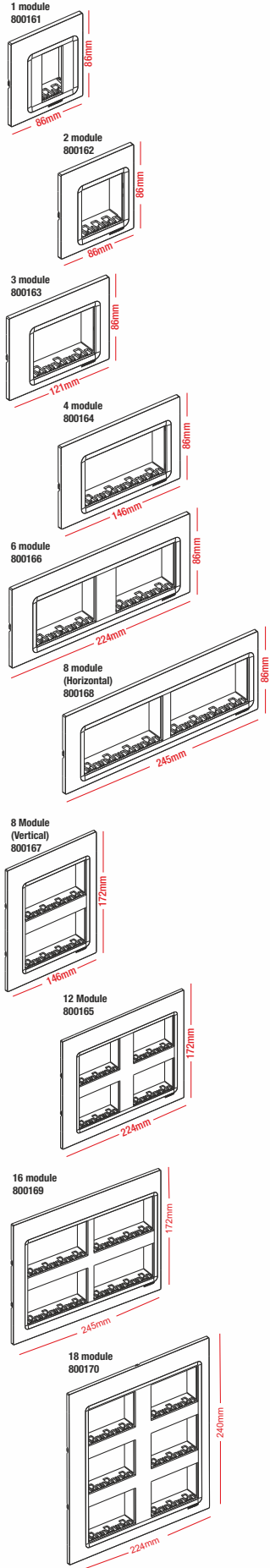

Flush Boxes-Metal

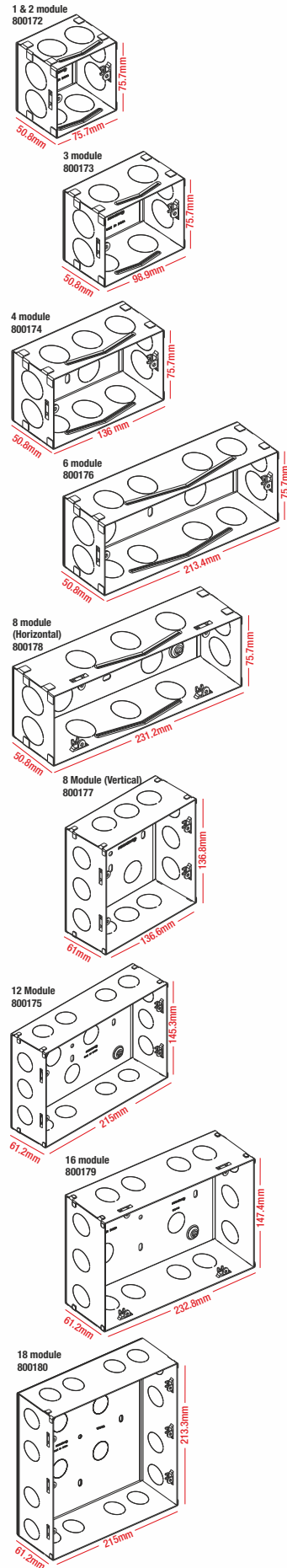

Surface Boxes

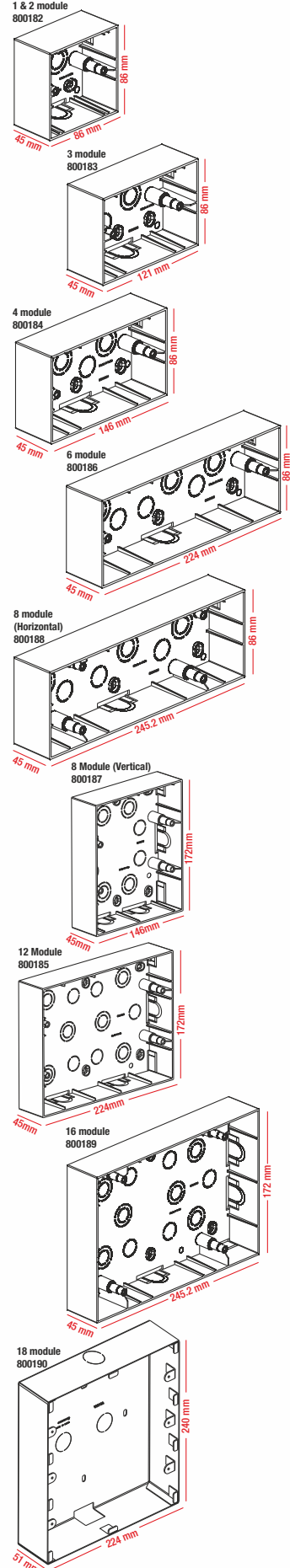

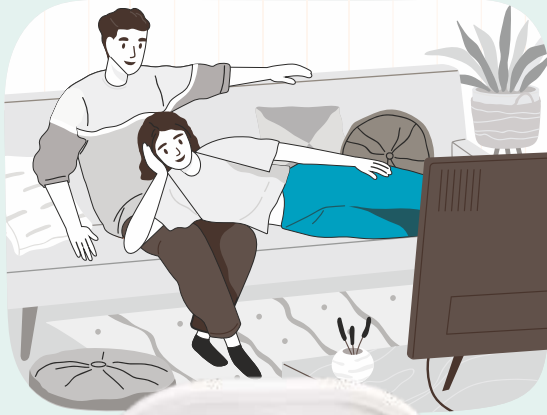

WHITE MATTE FINISH WITH AN AESTHETIC DESIGN THAT ALLOWS EASY GRIP



White matte finish



Value for money



6A & 16A



Tested as per
IS 1293

PLUGS

GENERAL TERMS

- This price list supersedes all previous price lists.
- All prices are in Indian Rupees only.
- All prices are Maximum Retail Prices (MRP) inclusive of GST as applicable.
- Our discount structure is exclusive of GST
- Orders will be accepted in multiples of standard packing.
- Prices are subject to change without notice. All despatches will be as per prices prevailing on the date of despatch. Prices are ex-godown, exclusive of packing/forwarding/freight and insurance.
- Product design is subject to change without notice for continuous up gradation.
- Disputes if any are subject to Delhi Jurisdiction only.
- Company reserves the right to issue amendments which may arise due to any printing errors in the price list.

WARRANTY

IA products carry a warranty against manufacturing defects, subject to use of the product for the right application, with correct wiring/connection and normal operating conditions. Please refer to detailed IndoAsian warranty policy effective 1st Jan 2016.

MCBs	36 Months
RCCBs	36 Months
DBs/ACCL	12 Months
Rewirable/HRC Fuses	6 Months
MCCBs/BFF/Fuse Bases/Changeover Switchgears/SDF	12 Months
Time Switches	12 Months
For Wiring Devices - Switches & Socket	120 Months
For Wiring Devices - Electronic Products (e.g. Fan Regulator, Dimmer, Buzzer, RJ45, RJ11 & TV Sockets, Bell Indicator, Motor starter, Skirting light)	24 Months

CHANNEL PARTNER

CORPORATE OFFICE: V. J. Business Towers, A-6, 1st Floor, Sector-125, Noida-201301, U.P., India. Ph.: +91-0120-3305111 E-mail: customer.care@indoasian.com, international@indoasian.com Website: www.indoasian.com

CUSTOMER CARE HEAD: Novateur Electrical & Digital Systems Pvt. Ltd., V. J. Business Towers, A-6, 1st Floor, Sector-125, Noida-201301, U.P., India.
Ph.: +91-0120-3305100 Toll Free no. 1800 103 7077 E-mail: customer.care@indoasian.com

NORTH

**Regional Sales office
DELHI NCR**

V. J. Business Towers
A-6, Ground Floor,
Sector-125, Noida-201303
Ph.: 0120-6858900

**Branch office
CHANDIGARH**

S.C.O.-11, 2nd Floor,
Sector-26, Madhya Marg,
Chandigarh-160002
Ph.: 0172-3934651

**Branch office
JAIPUR**

433, 4th Floor, Ganpati Plaza,
M. I. Road,
Jaipur-302001
Ph.: 0141-4113528

**Branch office
LUCKNOW**

301, 3rd Floor, Chintel House,
Station Road,
Lucknow-226001
Ph.: 0522-4013210

SOUTH

**Regional Sales office
BANGALORE**

787, 1st Floor "Skyline Vista"
15th Cross, 100 Feet Ring Road
J P Nagar 1st Phase
Bangalore-560 078
Tel: 080-46219999

**Branch office
COCHIN**

Door No.85/1317, Syda Building,
2nd Floor, Kaloor-Kadavanthra Road,
Kaloor, Ernakulam District,
Kochi-682017 (Kerala)
Ph.: 0484-4055581-88

**Branch office
COIMBATORE**

Door No. 83,
Dr. Nanjappa Road,
Coimbatore-641018
Ph.: 0422-2302715

**Branch office
CHENNAI**

No.5, 1st Floor, Mahalingapuram Main Road,
Nungambakkam,
Chennai-600034
Ph.: 044-28172096, 28170527

**Branch office
HYDERABAD**

312, 3rd Floor,
Amrutha Estates, Himayath Nagar,
Hyderabad-500029
Ph.: 040-66742425

WEST

**Regional Sales office
MUMBAI**

401 & 408, K.P. Arrum,
Marol Morshi Road, Andheri East,
Mumbai-400059
Ph.: 022-61035800

**Branch office
AHMEDABAD**

102, 1st Floor, Shivalik High Street,
Near Mansi Circle, Vastrapur,
Ahmedabad-380015
Ph.: 079-29701351-53

**Branch office
INDORE**

202, KK Bafna Arcade,
Janjeerwala Square,
Race Course Road,
Indore-452001
Ph.: 0731-4064064

**Branch office
PUNE**

311, Pride Silicon Plaza,
Bhamburda, Shivaji Nagar,
Senapati Bapat Marg,
Pune-411016
Ph.: 8087610722

EAST

**Regional Sales office
KOLKATA**

"Raikva Building" Room No. 8, 2nd Floor,
3A Ram Mohan Garden Lane,
Beliaghata E.M.Bypass, Kolkata-700010
Ph.: 033-66041503

IA/Price List/04-22/5500



WESUPPORT

E-mail: customer.care@indoasian.com

